

-MO DE SI GN-



Rigosalotti

Creare tendenza
soddisfacendo
il vostro bisogno
di casa

*Set a trend while
meeting your
requirements
at home*

Rigosalotti

Salotti Made in Italy dal 1984

Rigosalotti opera nel settore del mobile imbottito dal 1984, ponendosi sempre un passo in avanti rispetto alle mode e alle correnti del mercato. L'esperienza di oltre 30 anni di attività e la capacità di saper combinare artigianalità, design e processi produttivi di ultima generazione ci permette di offrire al cliente prodotti di assoluta qualità in grado di unire funzionalità ed estetica. La collezione Rigosalotti comprende oggi divani imbottiti in pelle e tessuto, divani prontoletto, letti imbottiti e sedute relax, complementi di arredo. L'intero processo produttivo viene gestito internamente, dalla fabbricazione delle strutture in legno e delle imbottiture al taglio e cucito dei rivestimenti, fino all'assemblaggio del prodotto finito. La continua ricerca di soluzioni innovative, la formazione e l'aggiornamento dei nostri tecnici specializzati ed una rete commerciale profondamente radicata nel territorio ci permette di garantire ai nostri clienti un elevato standard qualitativo 100% Made in Italy.

Living room Made in Italy since 1984

Rigosalotti has been in the upholstered furniture industry since 1984, positioned always one step ahead of market fashions and trends. More than 30 years experience in the business and the ability to combine craftsmanship, design and latest-generation production processes enable us to offer customers high quality products that combine practicality and aesthetics. The Rigosalotti collection now includes upholstered leather and fabric sofas, sofa-beds, upholstered beds, comfortable chairs and furnishing accessories. The whole manufacturing process is carried out in-house, from the construction of the wooden frames and the upholsteries to the cutting and sewing of the covers and assembly of the finished product. The non-stop search for innovative solutions, the training and refresher courses for our specialist technicians and a sales network firmly established in the local market enable us to guarantee our customers high quality products, 100% Made in Italy.

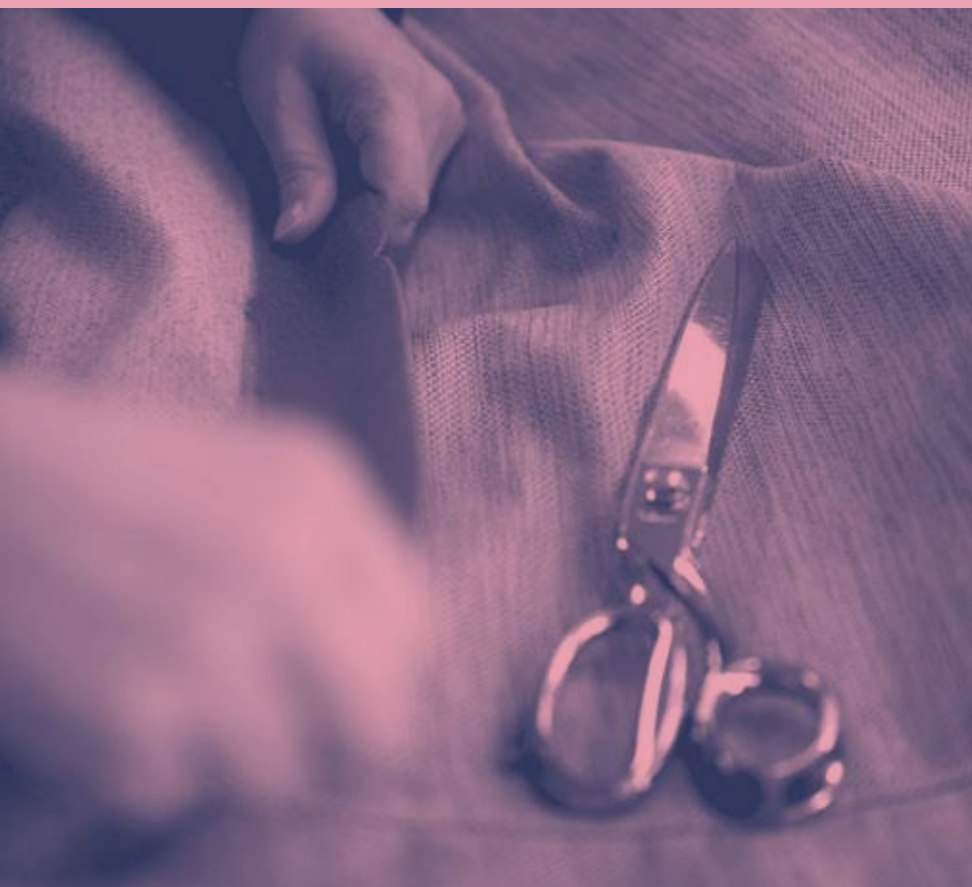

Prodotti evoluti
che creano innovazione
nel mercato.

*Advanced products
displaying innovation
in the market.*

Filosofia

Materiali d'eccellenza, competenza artigianale e creatività sono i concetti alla base dell'identità di Rigosalotti. La costante ricerca di soluzioni capaci di coniugare eleganza, funzionalità ed originalità rendono i nostri prodotti protagonisti assoluti dello spazio abitativo. Dalle geometrie più rigorose alle forme più avvolgenti, ogni prodotto esprime un design unico ed irripetibile, dedicato interamente a garantire al nostro cliente il massimo del comfort possibile. Divani, letti e complementi che raccontano l'esperienza e lo sviluppo tecnologico che ci accompagnano da oltre 30 anni.

Philosophy

Superior quality materials, expert craftsmanship and creativity are the concepts at the heart of Rigosalotti's identity. The continuous search for solutions that combine elegance, practicality and originality make our products the unqualified highlight of any living room. Ranging from the strictly geometric to softer, more enveloping shapes, every item presents a unique and exclusive design, entirely dedicated to providing our customers with the greatest possible comfort. These sofas, beds and accessories are testament to the experience and technical development that have guided us for over 30 years.

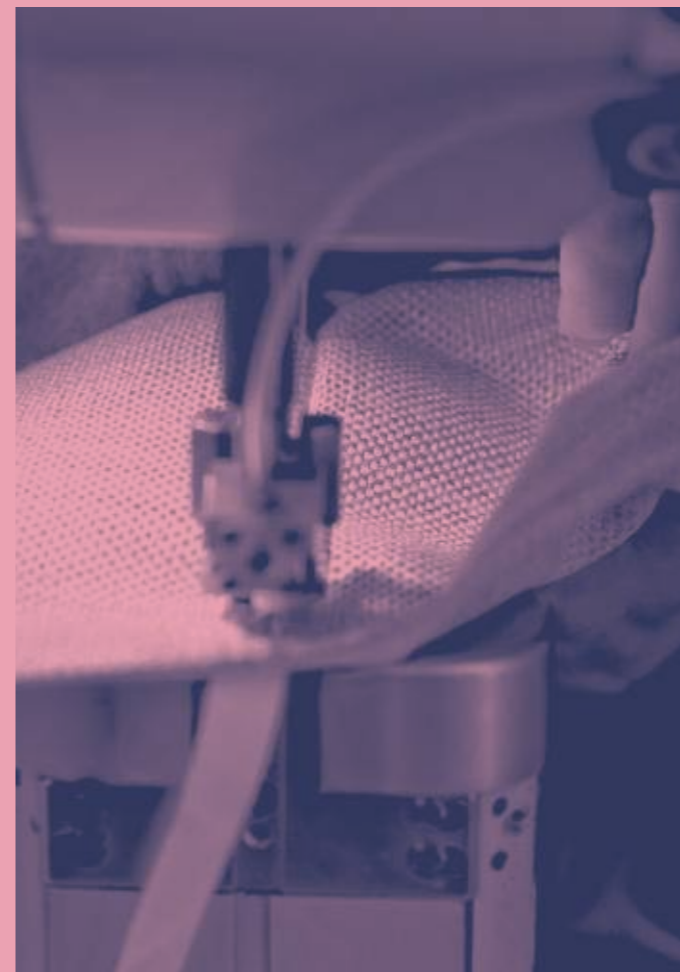

Artigianalità sartoriale
per lavorazioni 100%
Made in Italy.

*Sartorial craftsmanship
for products that are 100%
Made in Italy.*



Qualità costruttiva

Uno sguardo all'interno di un imbottito Rigosalotti, la percezione della solidità di una struttura in legno, la certezza della qualità e la tracciabilità dei rivestimenti utilizzati per le nostre creazioni sono solo alcuni degli elementi che assicurano in ogni nostro prodotto comodità e durevolezza che non temono confronti.

Build quality

A glance inside a Rigosalotti upholstered product, recognition of the sturdiness of a wooden frame and assurance of the quality and traceability of the covering materials used in our designs are just some of the elements in each of our products guaranteeing comfort and durability that are second to none.

Selezioniamo i migliori materiali sul mercato per garantire i più elevati standard qualitativi.

We select the best available materials to ensure the highest quality standards.

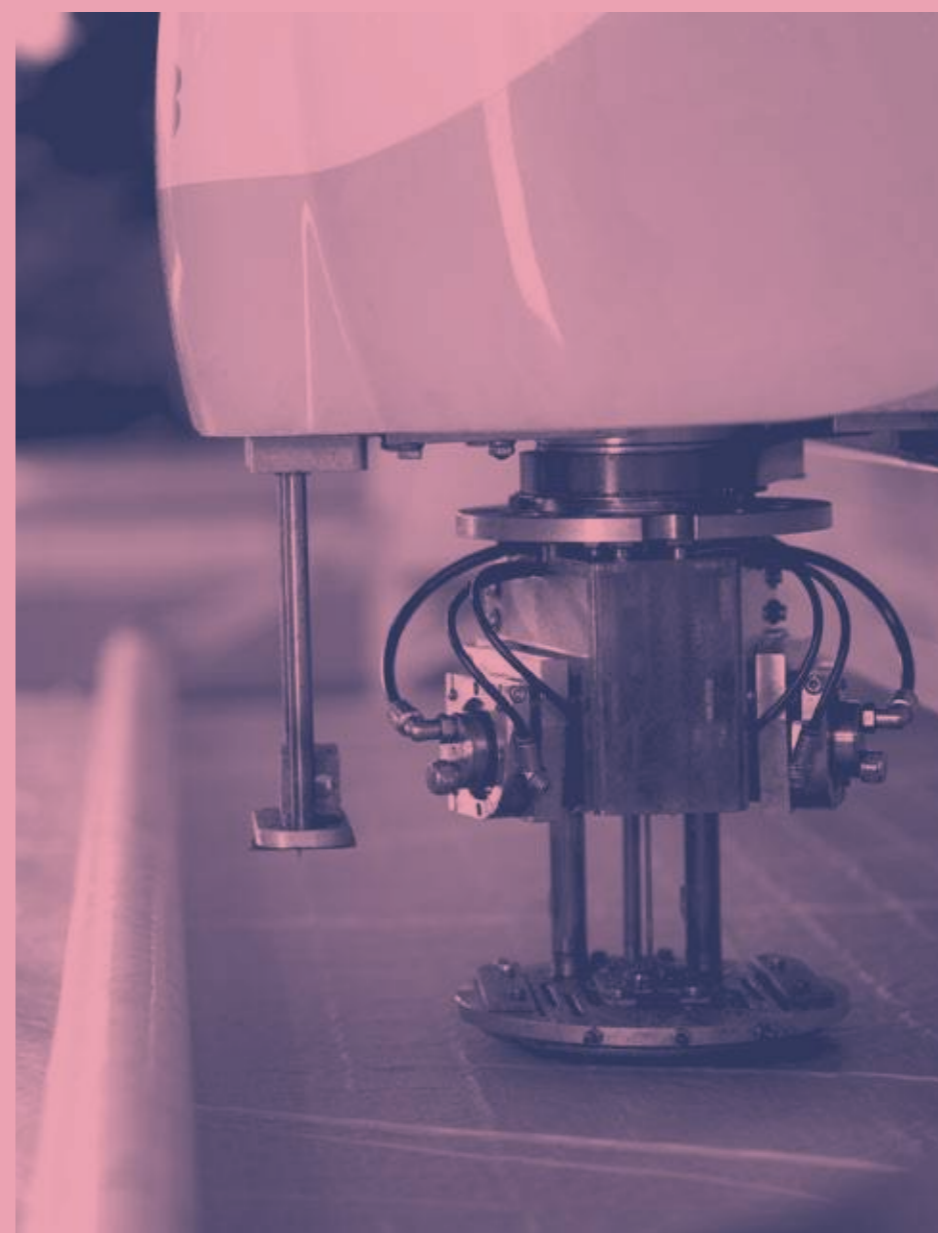

Giroletti: un'ampia scelta di configurazioni, permettono di dare una personalizzazione in più ai nostri modelli.

Bed frames: a wide choice of configurations makes further customisation possible in all models.

Versioni: tutti i nostri imbottiti sono proposti anche nella versione con letto, eccetto per alcuni modelli il cui design non lo permette. Sono tutti componibili esclusi i modelli più classici per ovvi motivi estetici.

Versions: all our upholstered products are also available in the sofa bed version, except for certain models where the design does not permit it. They are all modular apart from the most traditional models, for obvious aesthetic reasons.





Braccioli: cuscini in falda. Cuscini in poliuretano e falda. Cuscini con supporto in poliuretano espanso e mistopiuma e rivestiti in tela di cotone.

Armrests: cushions in batting. Cushions in polyurethane and batting. Cushions with supports in polyurethane foam and feather mix, covered in cotton cloth.

Rivestimenti: più di 1000 rivestimenti, dalla pelle al puro cotone, alla microfibra, totalmente sfoderabili, per rivestire i vostri imbottiti.

Covers: more than 1,000, fully removable, options from leather to natural cotton or microfiber for covering your furniture.



Materassi: in poliuretano espanso indeformabile ad alta densità, a molle o in memory foam rivestiti in tela di cotone.

Mattresses: in non-deformable high density polyurethane foam, with springs or memory foam, covered in cotton cloth.



Creare tendenza
soddisfacendo
il vostro bisogno
di casa
*Set a trend while
meeting your
requirements
at home*

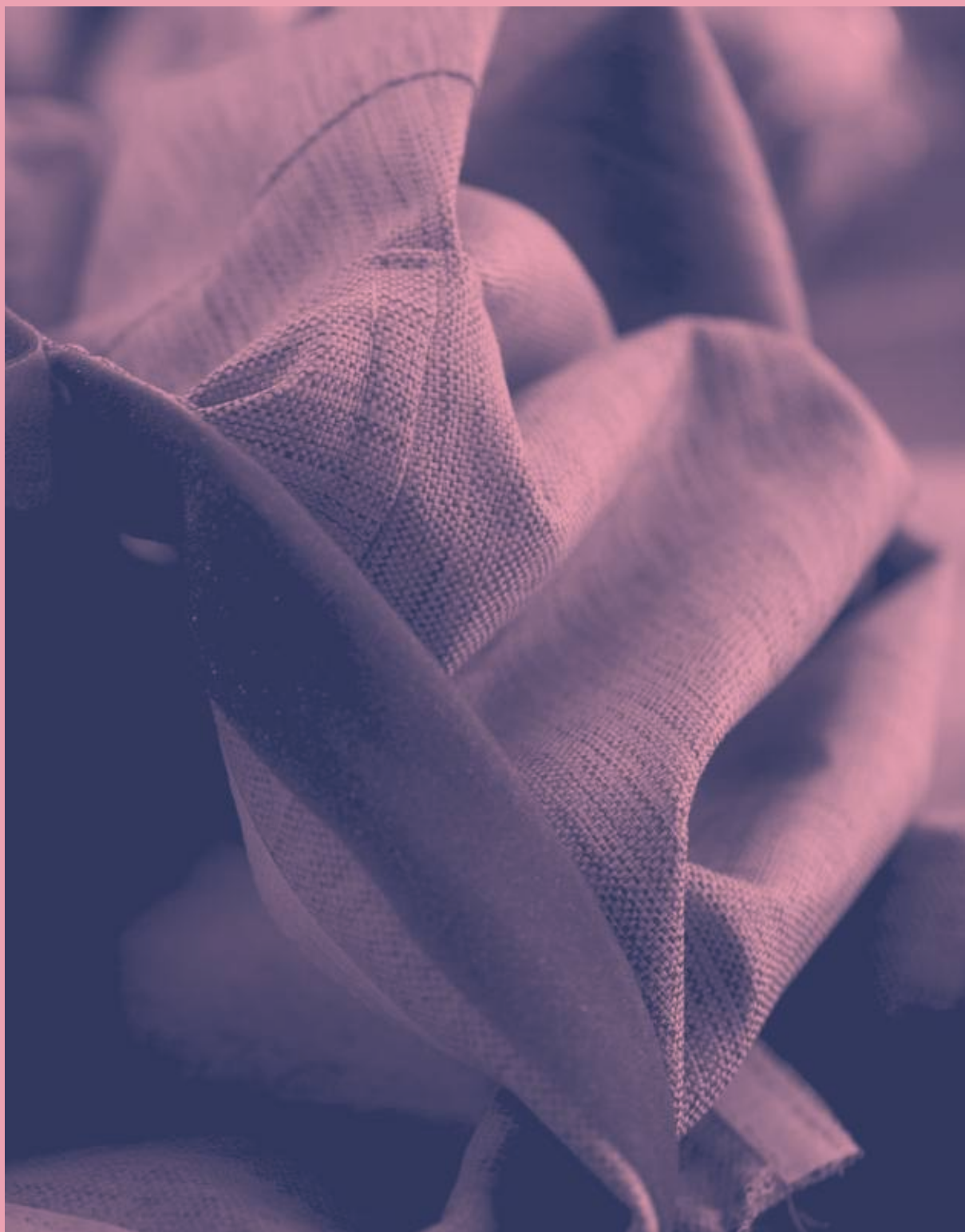

Indice | Index

| | |
|----------------------------------|-----------|
| Divani Sofas - Design | 6 - 185 |
| Divani Sofas - Moderno | 186 - 309 |
| Complementi Complements | 310 - 351 |

Divani | Sofas - Design



Flamingo p. 8



Ballarò Plus p. 16



Ballarò Low p. 22



Drive p. 26



Airo p. 116



Santos p. 126



Green p. 132



Capohorn p. 138



Roll-Plaz p. 32



Nest p. 38



Sistema p. 44



Soffy p. 50



Oceano p. 144



Sintesi p. 152

Divani | Sofas - Moderno



Nemo p. 56



Quark p. 64



Etoile p. 74



Kayo p. 80



Avalon p. 188



Tablet p. 194



Tylor p. 202



Volaria p. 212



Movie p. 86



Gregor p. 96



Everday p. 100



Soleil p. 110



Yoao p. 220



Astro p. 226



Feni SI p. 232



Feni SD p. 238



Kommodo p. 242



Soft p. 250



Misvago p. 256



Minimò p. 262



Vanity p. 330



Bea p. 334



Viva p. 336



Pratica p. 340



King p. 268



Zelig p. 272



Togo p. 276



Ray's p. 282



Soffice p. 342



Cubo small p. 344



Cubo big p. 344



Round small p. 344

Complementi | Complements



Bloom p. 312



Joy p. 314



Globe p. 316



Yoox p. 318



Round big p. 344



Esa p. 344



Oval p. 344

Tecnica | Technicals

Divani | Sofas - Design p. 160

Divani | Sofas - Moderno p. 288

Complementi | Complements p. 346



divani | sofa

Design

flamingo

Flamingo è caratterizzato da un design attuale che si fonde con stile e comfort facendo di questo divano il giusto compromesso tra eleganza e comodità. Grazie alla struttura in metallo che raccoglie e abbraccia i morbidi cuscini seduta e i soffici schienali, Flamingo crea un'atmosfera ideale per abbandonarsi al relax dimenticando lo stress quotidiano e sentendosi coccolati ma anche sicuri e sostenuti al punto giusto.

Flamingo is characterized by a current design that blends with style and comfort making this sofa the right compromise between elegance and comfort. Thanks to the metal structure that collects and embraces the soft seat cushions and the soft backrests, Flamingo creates an ideal atmosphere to indulge in relaxation, forgetting the daily stress and feeling pampered but also safe and supported at the right point.







Il raffinato gusto contemporaneo accompagnato agli accurati dettagli sartoriali e alla varietà di tessuti disponibili, consentono a Flamingo di creare infinite ed armoniche soluzioni d'arredo valorizzando la stanza in cui viene posizionato.

The refined contemporary taste accompanied by accurate sartorial details and the variety of fabrics available, allow Flamingo to create infinite and harmonious furnishing solutions, enhancing the room in which it is placed.

L'originalità della forma e la leggerezza che lo caratterizza fanno in modo che si possa adattare sia ad un ambiente classico che moderno. La geometrica forma dei piedini accompagnata alla soffice imbottitura di schienali e sedute danno la sensazione di sognante sospensione e leggerezza esaltata maggiormente dalla finitura scura dei braccioli in metallo.

The originality of the shape and the lightness that characterizes this sofa, allow it to adapt to both a classic and a modern environment. The geometric shape of the feet accompanied by the soft padding of the backrests and seats give the sensation of dreamy suspension and lightness further enhanced by the dark finish of the metal armrests.





ballarò plus

Comodo salotto caratterizzato da schienali e braccioli dotati di meccanismo traslante che permette di modificare in profondità e larghezza la seduta per un maggior comfort.

Comfortable sofa characterized by backrests and armrests equipped with a translating mechanism that allows you to change the depth and width of the seat for greater comfort.







Il movimento del bracciolo traslante, permette di ottenere la posizione ideale per tutte le esigenze. Un'innovazione che crea un sistema originale e dinamico senza rinunciare ad armonia e comfort.

The movement of the translating armrest allows to obtain the ideal position for all needs. An innovation that creates an original and dynamic system without sacrificing harmony and comfort.

Ballarò plus viene proposto con comodi schienali monoscocca alti ed ergonomici dove potersi accomodare appoggiando il capo per il massimo relax quotidiano. Il particolare design di questo divano assicura un tocco di eleganza e di originalità per soluzioni di grande effetto.

Ballarò plus is proposed with comfortable high and ergonomic monocoque backrests where you can sit and rest your head for maximum daily relaxation.

The particular design of this sofa ensures a touch of elegance and originality for solutions of great effect.



ballarò low



Comodo salotto caratterizzato da schienali e braccioli dotati di meccanismo traslante che permette di modificare in profondità e larghezza la seduta per un maggior comfort.
La versione low si caratterizza per lo schienale traslante formato da un cuscino ancorato ad una struttura dal design sottile e moderno.

*Comfortable sofa characterized by backrests and armrests equipped with a translating mechanism that allows you to change the depth and width of the seat for greater comfort.
The low version is characterized by the translating backrest formed by a cushion anchored to a backrest with a slim and modern design.*



drive



Divano completamente sfoderabile con diverse soluzioni di componibilità che permette di sopperire alle diverse esigenze di spazio e di funzionalità.

Sofa with completely removable covers with different modular solutions that allows you to meet the different needs of space and functionality.





Dotato di serie di schienali poggiatesta con sistema di regolazione manuale a cricchetto, offre il massimo comfort quotidiano.

Equipped as standard with headrest backrests with manual ratchet adjustment system, it offers maximum daily comfort.

Corredato di sedute tutte indipendenti possono essere fisse o a richiesta scorrevoli con meccanismo manuale o elettrico con telecomando wireless.

Equipped with all independent seats, they can be fixed or sliding on request with manual or electric mechanism with wireless remote control.



roll-plaz

Relax totale come punto cardine per il divano Roll-Plaz, le sue sedute tutte indipendenti con meccanismo manuale di scorrimento di serie permettono di aumentarne la profondità e assieme agli schienali con sistema di regolazione a cricchetto assicurano il massimo comfort.

Total relaxation as a central point for the Roll-Plaz sofa, its independent seats with sliding mechanism allow you to increase its depth and together with the backrests with ratchet adjustment system comply maximum comfort.







Divano con seduta estraibile a meccanismo di scorrimento manuale, permette di usufruire al bisogno di una profondità maggiore che assicura una posizione di relax e la possibilità di distendersi comodamente come su di una penisola.

Sofa with extractable seat with manual sliding mechanism, it allows you to take advantage of a greater depth when needed, which ensures a relaxing position and the possibility of relaxing comfortably like on a peninsula.

Salotto completamente sfoderabile completo di meccanismo manuale a cricchetto su tutti gli schienali.

Completely removable seating complete with manual ratchet mechanism on all backrests.



nest



Un divano dalla personalità forte e dalla sofisticata ricchezza di dettagli, le curve armoniose dei suoi elementi avvolgenti dichiarano tutta la sua comodità e l'originale gioco di pieghe sulla struttura, che ricorda un origami, ne sottolinea l'accurata manifattura.

A sofa with a strong personality and sophisticated richness of details, the harmonious curves of its enveloping elements declare all its comfort and the original play of folds on the structure, reminiscent of origami, emphasizes its careful manufacturing.





Il divano Nest è dotato di morbidi cuscini che fungono da bracciolo e sono resi stabili da potenti calamite che li ancorano al fianco del divano, ma al tempo stesso rimangono elementi movibili qual'ora si presentasse l'esigenza di toglierli.

The Nest sofa is equipped with soft cushions that act as an armrest and are made stable by powerful magnets that anchor them to the side of the sofa, but at the same time they remain movable elements if someone need to remove them.

Divano dalle linee essenziali caratterizzate dalla forma armoniosa e sobria. Ben si adatta sia ad un ambiente di tipo classico che moderno.

Sofa with essential lines characterized by a harmonious and sober shape. It is well suited to both a classic and modern environment.



sistema



Divano innovativo caratterizzato dalla versatilità e dall'originalità della costruzione. Dotato di schienali e braccioli smontabili, permette di spostare i vari elementi a piacimento creando elementi reversibili destri e sinistri di varie forme e proporzioni. La quantità di schienali può essere variata a piacimento in base alle esigenze di dimensioni e capienza.

Innovative sofa characterized by the versatility and originality of the construction. Equipped with removable backrests and armrests, it allows you to move the various elements in order to creating right and left reversible elements of various shapes and proportions. The quantity of backrests can be varied according to size and capacity requirements.



Composizione realizzata con elemento laterale 3/P piccolo da 209 cm con terminale sagomato da 134x198 cm corredato di schienali piccoli.

Composition made with small 209 cm 3 seat side element with 134x198 cm shaped end unit equipped with small back panels.



Sistema è un divano moderno e di design realizzato con schienali in misto piuma supportati da una struttura metallica che posizionata all'interno di un'apposita feritoia perimetrale permette di variarne la posizione. Lo stesso può essere fatto con i braccioli che spostati possono variare il verso dei vari elementi dove vengono posizionati.

Sistema is a modern and design sofa made with mixed feather backrests supported by a metal structure which, positioned inside a special slot, allows you to vary its position. The same can be done with the armrests which, when moved, can vary the direction of the various elements in which they are positioned.



soffy



Divano di design dalla linea innovativa caratterizzata dall'ampia seduta effetto trapuntato, completamente sfoderabile e reversibile. Dotato di cuscini mobili è il divano ideale per chi cerca qualcosa di unico e versatile, al di fuori degli schemi fissi tradizionali.

Design sofa with an innovative line characterized by the large seat effect quilted, completely removable and reversible. Equipped with movable cushions, it is the ideal sofa to whom looking for something unique and versatile, outside the traditional fixed schemes.



Composizione realizzata con base da 223 cm con schienale confort e base da 163 cm con 2 schienali imbottiti.

Composition made with base 223 cm with confort backrest and base 163 cm with 2 padded backrests.

Soffy dispone di supporti e cuscini di diversa dimensione e forma che fungono da schienale e grazie all'originalità della struttura riescono a soddisfare le diverse esigenze. Il cliente può a sua discrezione decidere il numero di elementi da posizionare sopra la base.

Soffy has supports and cushions of different sizes and shapes that act as a backrest and thanks to the originality of the structure it is able to satisfy different needs. The customer can at his discretion decide the number of elements to be placed on the base.



nemo



Nemo è un moderno sistema di dormeuse modulare, caratterizzato da linee nitide e pulite in cui le finiture sono ridotte ai minimi termini. Ogni dettaglio è studiato per esaltare al massimo la purezza formale e le proporzioni nitide della struttura: dai profili a contrasto ai piedini realizzati in tubo metallico sagomato e verniciato, sino agli schienali, semplici cuscini quadrati o parallelepipedi imbottiti.

Nemo is a modern system of modular daybed, characterized by clear and neat lines in which the finishes are reduced to their bare essentials. Every detail is designed to maximize the formal purity and the clear proportions of the structure: from the contrasting profiles to the shaped and painted metal tube feet, up to the backrests, simple padded square or parallelepiped cushions.



Il sistema Nemo è un infinito "domino" di morbidi volumi in cui l'ampia seduta, disponibile in 5 lunghezze (da 160 a 240 cm) e le tre tipologie di schienale, tutte con cuciture e rivestimenti a contrasto, offrono la possibilità di creare divertenti e versatili spazi di convivialità. Assolutamente contemporaneo nello stile, questo sistema fa dell'essenzialità il suo punto di forza.

Nemo system is like an infinite "domino" made of soft volumes. Its large seats, available in 5 lengths (from 160 to 240 cm) and the three types of backrest with contrasting stitching and coverings, offer the possibility of creating fun and versatile spaces of conviviality. Absolutely contemporary in style, this system chooses the essentiality as its strong point.





quark



Quark è un divano con rivestimento completamente sfoderabile caratterizzato da elementi curvi e ad angolo di diverse dimensioni, con bracciolo dalla linea particolare e squadrata che ne arricchisce lo stile pulito ed elegante.

Quark is a sofa with completely removable cover characterized by curved corner elements available in different size and an armrest with a particular and squared line that enriches its clean and elegant style.





Divano caratterizzato da elementi curvilinei quali l'angolare tondo, personalizzabile da una serie di cuscini realizzabili nei diversi e vari colori disponibili a campionario, perfetto per un salotto contemporaneo e per chi ricerca comfort, design e qualità.

Sofa characterized by curvilinear elements such as the round corner, which can be customized with a series of cushions that can be made in the different and various colors available in the Samples, perfect for a contemporary living room and for those looking for comfort, design and quality.





L'elemento pouf angolo permette di impreziosire la composizione angolare aggiungendo un tocco di classe e di stile al salotto.

The corner pouf element allows you to embellish the corner composition by adding a touch of class and style to the living room.

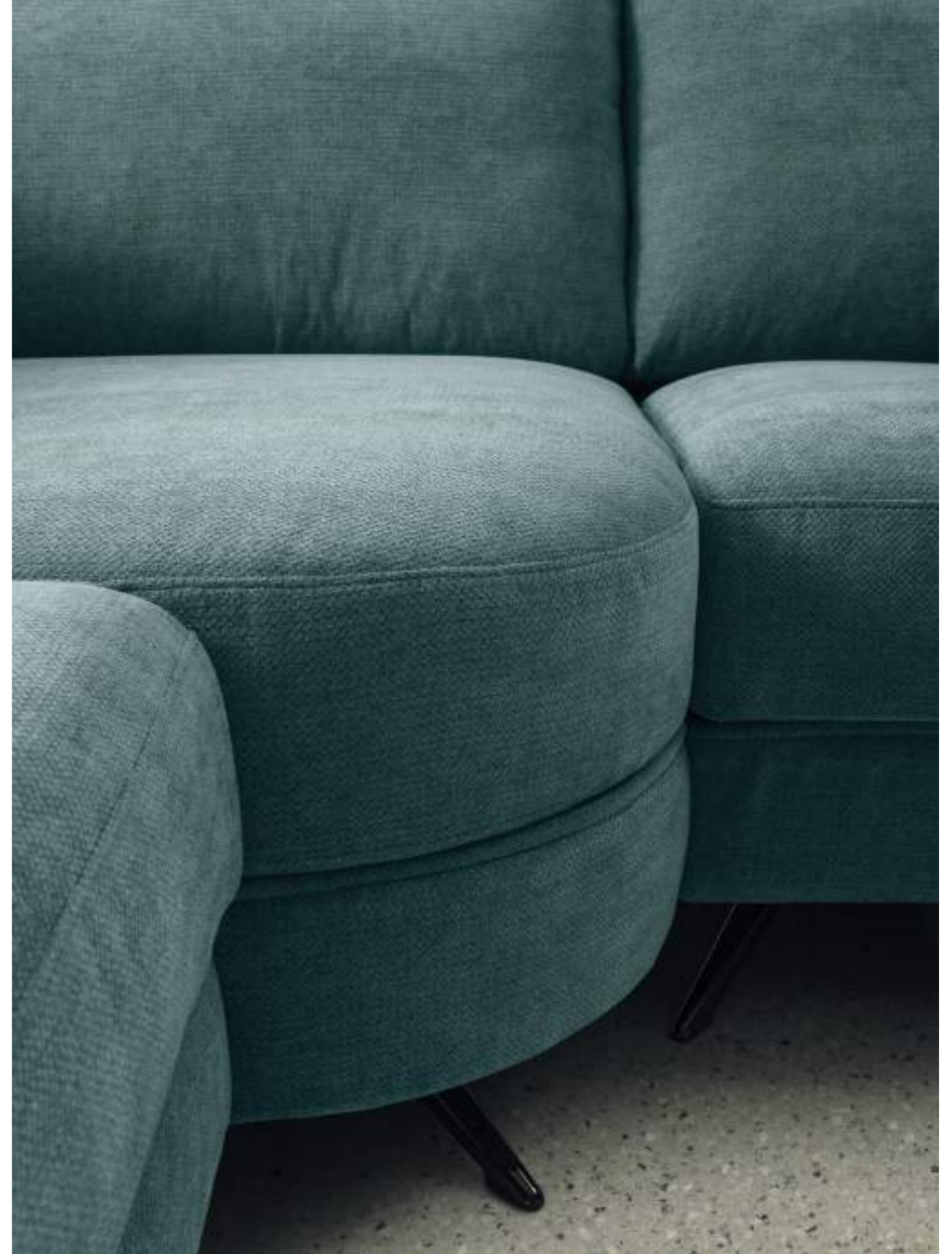

etoile

Stile sobrio e rigoroso per un sistema componibile di grande effetto. Etoile disegna lo spazio con le sue severe forme geometriche che, le cuciture a punto cavallo disponibili a contrasto o in tinta con il rivestimento, sdrammatizzano rendendole in qualche modo più vivaci e giocose.

A sober and rigorous style characterize this highly effective modular system. Etoile draws the space with its severe geometric shapes that the stitching, contrasting or with the same color of the covering, make more lively and playful.

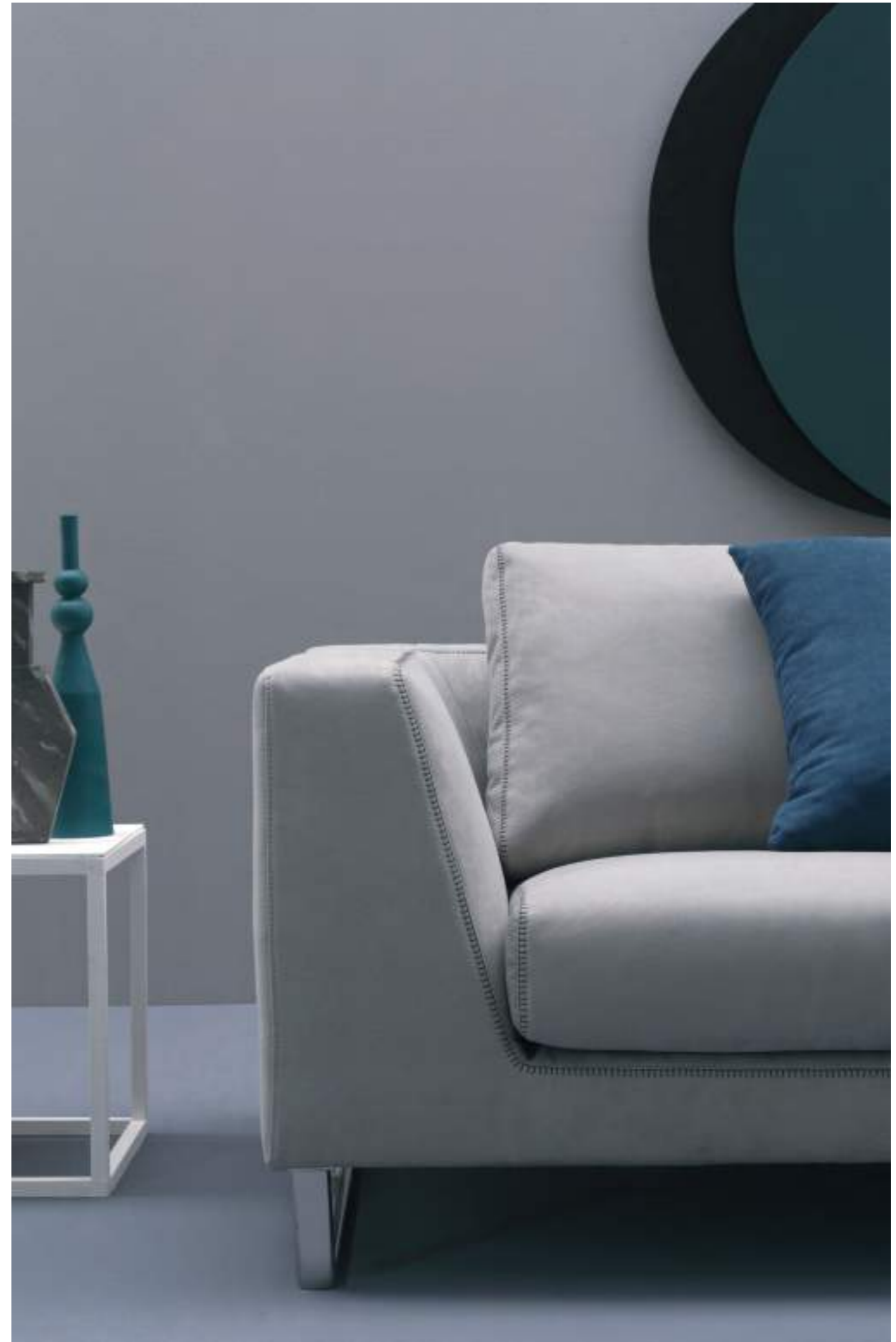





Tratto originale e distintivo di questo divano è la cucitura a punto cavallo che può essere realizzata su richiesta del cliente in tinta oppure a contrasto.

The original and distinctive detail of this sofa is the blanket stitching which can be made on request of the customer in the same color or in contrast.

Il rigore formale, il savoir-faire ed i materiali di pregio si incontrano per dar vita ad un divano dal design elegante ed essenziale, perfetta sintesi di comfort e robustezza. Le lunghe ed esili staffe in metallo cromato, il pregio dei rivestimenti completamente sfoderabili, la cura sartoriale delle cuciture, tutto parla di qualità.

Accuracy, know-how and precious materials has combined here to create a sofa with an elegant and essential design, a perfect synthesis of comfort and robustness. Its superior quality is clear in every details: the long and slim chrome metal brackets, the quality of the covers (completely removable) and the sartorial stitching made with great care.



kayo

Kayo è un divano moderno con cuscini schienale in appoggio caratterizzato da un design essenziale, senza eccessi decorativi, ma curato nei dettagli. I volumi generosi, i cuscini poggiatesta e i piedini alti in metallo esaltano il concetto di leggerezza e comfort che contraddistingue questo divano.

Kayo is a modern sofa with supporting back cushions characterized by an essential design, without decorative excesses, but with attention to detail. The generous volumes, the lumbar cushions and the high metal feet enhance the concept of lightness and comfort that distinguishes this sofa.







Kayo si pregia di una linea contemporanea e imponente alleggerita dal piede a balestra che ne slancia la forma.

Kayo prides itself on a contemporary and imposing line lightened by the crossbow foot which streamlines its shape.

Elemento distintivo di questo divano è il comodo schienale alto con snodo a frizione che permette di inclinare la parte poggiatesta a proprio piacimento per il massimo comfort.

The distinctive element of this sofa is the comfortable high backrest with friction joint that allows you to tilt the headrest as you like for the maximum comfort.



movie

Movie è un divano componibile, moderno e ricercato, caratterizzato da profonde ed accoglienti sedute, finiture a contrasto ed originali piedini in acciaio cromato. Un sistema in grado di abbinare in maniera impeccabile comfort e stile, dando vita ad un design eclettico che gli consente un'armonica collocazione in qualsiasi contesto d'arredo.

Movie is a modular sofa, modern and sophisticated, characterized by deep and cozy seats, contrasting finishes and original chromed steel feet. A system that perfectly combines comfort and style, creating an eclectic, but also harmonious, design ideal for any furnishing context.







Nella versione con penisola, Movie esprime il meglio di sé grazie anche al meccanismo basculante indipendente, che permette di regolare la profondità della singola seduta consentendo ad ognuno il massimo della comodità.

Movie excels in the peninsula version, thanks to the independent tilting mechanism which allows to adjust the depth of the single seat, enabling maximum comfort for each individual.





Lo stile ricercato di Movie e la grande flessibilità delle finiture esalta l'eccellenza dei materiali e la grande cura dei particolari, come il basamento aereo con i piedi in finitura cromo, in grado di conferirgli una grande personalità.

The refined style of Movie and the great flexibility of the finishes enhance the excellence of the materials and the great attention to detail, such as the aerial base with feet in a chrome finish, enable it of a great personality.



gregor



Divano dal design lineare è proposto con ampi cuscini schienale per un effetto più imponente e geometrico. Nella versione con dormeuse viene completato da una serie di cuscini decorativi per una soluzione versatile e moderna. I braccioli imbottiti sono ampi e sagomati per accogliere perfettamente i cuscini di seduta e offrire un importante appoggio per chi siede e vuole il massimo comfort.

Sofa with a linear design is proposed with large back cushions for a more imposing and geometric effect. In the version with daybed it is completed by a series of decorative cushions for a versatile and modern solution. The padded armrests are wide and shaped to perfectly accommodate the seat cushions and offer important support for those who sit and want maximum comfort.





everday

Divano impreziosito dalle finiture artigianali, linee pulite che rendono Everyday il divano moderno e funzionale. Dalle forme apparentemente semplici, di fatto rivela inediti particolari di stile come il cuscino poggiatesta che garantisce il massimo comfort quotidiano.

Sofa embellished with handcrafted finishes, clean lines that make Everyday the modern and functional sofa. With apparently simple shapes, in fact it reveals unprecedented style details such as the lumbar cushion that guarantees maximum daily comfort.







Gli schienali dispongono di sistema di regolazione a cricchetto manuale e abbinati al cuscino poggiatesta assicurano il massimo comfort.

The backrests have a manual ratchet adjustment system and combined with the lumbar cushion they ensure maximum comfort.

La varietà di elementi di cui si compone Everyday abbinata alla vasta scelta di tessuti disponibili, permette di realizzare composizioni originali e funzionali.

The variety of elements that make up Everyday combined with the vast choice of fabrics available allows you to create original and functional compositions.





Everday è un divano moderno che può essere abbinato ad una comoda penisola personalizzabile in un'ampia gamma di colori e rivestimenti. Comfort e relax contraddistinguono Everday grazie alla comoda e ampia seduta e ai braccioli larghi imbottiti; il divano viene inoltre proposto con morbidi cuscini poggiatesta per offrire maggiore comodità alle sedute.

Everday is a modern sofa that can be combined with a comfortable customizable peninsula in a wide range of colors and coverings. Comfort and relaxation distinguish Everday thanks to the comfortable and wide seat and wide padded armrests; the sofa is also proposed with soft lumbar cushions to guarantee greater seating comfort.



soleil



Divano di design caratterizzato dalla leggerezza delle forme con schienali in misto piuma che lo rendono molto confortevole e l'originale piede a balestra che ne slancia la linea.

Design sofa characterized by the lightness of the shapes with mixed feather backrests that make it very comfortable and the original leaf spring foot that slims the line.



Soleil ha una linea snella ed elegante impreziosita dal bracciolo sottile dotato di serie di un meccanismo a cricchetto per poterlo inclinare a proprio piacimento.

Soleil has a slender and elegant line embellished by the thin armrest equipped as standard with a ratchet mechanism to be able to tilt it as desired.



airo

Airo è un divano concepito con la solidità strutturale e le proporzioni nitide di un'architettura, in cui i volumi importanti e ben definiti vengono sdrammatizzati dai piedini in metallo verniciato.
Un sistema dal carattere dinamico nel quale i diversi elementi compongono un originale gioco di morbidi volumi.

*Airo is a sofa designed with the structural solidity and the clear proportions of an architecture, in which the metal details de-emphasize the important and well-defined volumes.
A dynamic system with different elements able to create an original play of soft volumes.*





Caratterizzato da rivestimenti di alta qualità e finiture impeccabili, Airo crea eclettici spazi di convivialità dove trascorrere il tempo libero con gli amici o rilassarsi ascoltando musica.

Characterized by high quality covers and flawless stitching, Airo creates eclectic spaces of conviviality perfect for social gatherings with friends or for listening music in complete relaxation.





Grazie agli elementi angolari, laterali e chaise longue, Airo può essere declinato nelle più diverse combinazioni, sia a parete che a centro stanza, creando sempre spazi equilibrati ed accoglienti. Molteplici anche le varianti colore dei tessuti di rivestimento disponibili.

Thanks to the corner elements, the side sections and the chaise longue, Airo can be adapted to many different arrangements, either against a wall or freestanding, always creating balanced and welcoming spaces. There are also many different colors of fabric covers available.



santos



Un'architettura orizzontale scandita dai braccioli laterali che caratterizzano le diverse versioni e configurazioni. Un divano essenziale e rigoroso, animato dal movimento degli schienali regolabili con meccanismo a cricchetto con ritorno automatico.

A horizontal architecture marked by the side armrests that characterize the different versions and configurations. An essential and rigorous sofa, animated by the movement of the adjustable backrests with ratchet mechanism with automatic return.





Schienali separati consentono di gestire in modo autonomo il proprio comfort, un sistema di regolazione pratico e dinamico con movimento progressivo di abbattimento.

Separate backrests allow you to independently manage your comfort, a practical and dynamic adjustment system with progressive felling movement.



green



Un divano che gioca intersecando volumi netti, un profondo equilibrio tra il rigore delle linee estetiche e la leggerezza dei suoi elementi. Green è disponibile in versione lineare o composta, un sistema componibile che caratterizza con eleganza lo spazio living.

A sofa that plays by intersecting clear volumes, a profound balance between the rigor of aesthetic lines and the lightness of its elements. Green is available in linear or composite version, a modular system that elegantly characterizes the living space.





I piedini alti gli conferiscono leggerezza formale e uno stile contemporaneo. Green può essere rivestito in un'ampia gamma di tessuti in grado di accontentare i gusti più esigenti.

The high feet give it formal lightness and a contemporary style. Green can be upholstered in a wide range of fabrics capable of satisfying the most demanding tastes.

Green si contraddistingue per il suo aspetto minimale e raffinato, impreziosito da linee di semplice e chiara leggibilità che lo rendono il divano per antonomasia.

Green stands out for its minimal and refined appearance, embellished by lines of simple and clear legibility that make it the sofa par excellence.



capohorn

Capohorn è un divano dallo stile inconfondibile, caratterizzato da una struttura di sostegno di braccioli e schienali dalle forme affilate, piedini alti in metallo cromato, rivestimenti di pregio ed un originale meccanismo a scatto nel poggiatesta in grado di garantire il massimo comfort.

Capohorn is a sofa with an unmistakable style, characterized by armrests and backsrest frame with angular shapes, high chrome feet, valuable coverings and an original snap mechanism in the headrest able to ensure maximum comfort.





Nella versione con chaise longue, Capohorn esprime al meglio le sue potenzialità: estremamente accogliente e confortevole, grazie alle forme generose, questo divano è in grado di ridisegnare l'ambiente e diventare il fulcro dello spazio abitativo.

This sofa expresses its full potential in the version with chaise longue: extremely cozy and comfortable, thanks to its generous shapes, Capohorn is able to redesign the space and become the crux point of the entire living room.



oceano



Oceano è un divano dalla linea essenziale, sobria e geometrica, ma dal carattere deciso. Originale nello stile, grazie soprattutto a seduta e schienale di colore diverso, è la scelta ideale per soluzioni di grande effetto, specie nella versione stand alone. Qui nulla è lasciato al caso: dalle aggraziate staffe in metallo, che quasi lo elevano dall'ambiente circostante, alle eleganti cuciture a contrasto.

Oceano is a sofa with an essential, sober and geometric line as well as a strong character. Its original style, mostly resulted from the different color of the seat and the backrest, makes it the ideal choice for creating highly impressive settings, especially in the freestanding version. Nothing is left to chance: from the graceful metal brackets, which almost elevate it from the ground, to the elegant contrast stitching.

Questo intreccio di dettagli, contrasti e design è il vero leitmotiv di Oceano. Lo si ritrova inalterato nell'elegante lavorazione a trapunta romboidale che ricorda, stilizzandole, le onde del mare e continua nell'inusuale bracciolo strutturato, dalla linea leggermente convessa, che conferisce al divano uno stile insieme minimale e vivace, comunque mai banale.

The interweaving between details, contrasts and design is the leitmotiv of Oceano. This is also evident in the elegant rhomboidal quilting on the backrest that reminds, stylizing them, the sea waves. The leitmotiv continues in the unusual structured armrest, with a slightly convex line, able to give it a minimal and lively, but never trite, style.







Nelle sue molteplici varianti di forma e rivestimento, questo divano mantiene inalterato il suo carattere contemporaneo e schietto. Grazie alla presenza di diversi colori ed elementi (dormeuse, laterali e pouf), Oceano è in grado di rispondere a qualsiasi esigenza d'arredo: dagli spazi più piccoli ai loft e saloni, senza mai rinunciare a comodità e stile.

In its many forms and covering, this sofa maintains unaltered its contemporary and pure character. Thanks to the presence of different colors and elements (daybed, side sections and ottoman), Oceano is able to meet any furnishing requirement: from the smallest spaces to lofts and lounges, without compromises his comfort and style.

sintesi

Sintesi è un sistema componibile che, grazie all'alternanza di sedute, penisole, dormeuse e pouf, crea accoglienti isole domestiche nelle quali vivere il proprio tempo libero in assoluto relax.

This is a modular system with a lot of elements available (fixed sofa, chaise longue, daybed and ottoman) that create a cozy domestic island in which it's a pleasure spending free time in absolute relaxation.







Un divano che supera il tradizionale concetto di comfort: semplicità formale e pulizia estetica si uniscono per dar vita a forme armoniche, accoglienti e funzionali in perfetto equilibrio tra eleganza, creatività e praticità.

This is a sofa that exceeds the traditional concept of comfort. Formal simplicity and aesthetic cleanness interact to create harmonious, welcoming and functional shapes in perfect balance between elegance, creativity and functionality.







tecnica
technical

flamingo

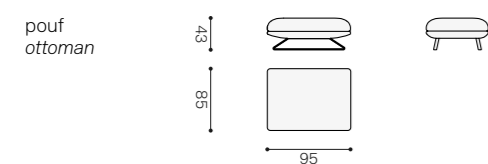
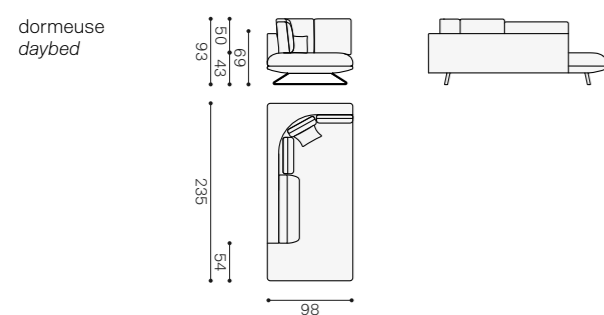
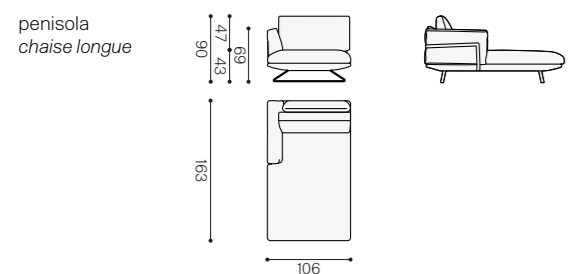
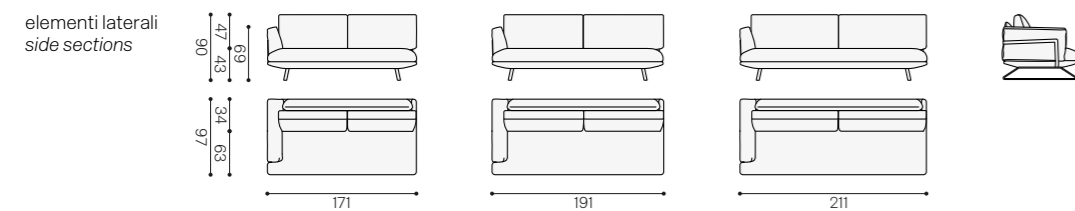
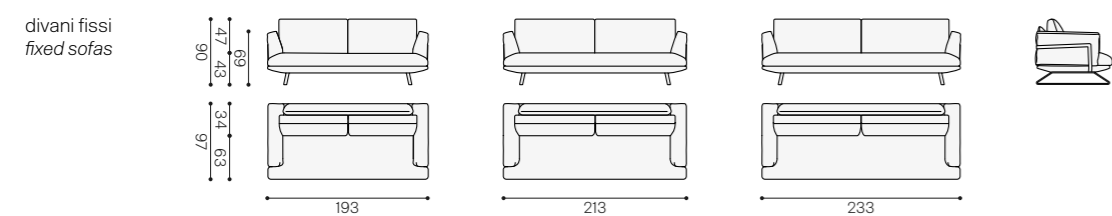

ballarò plus

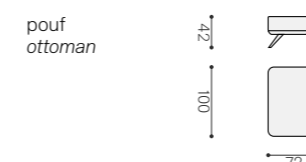
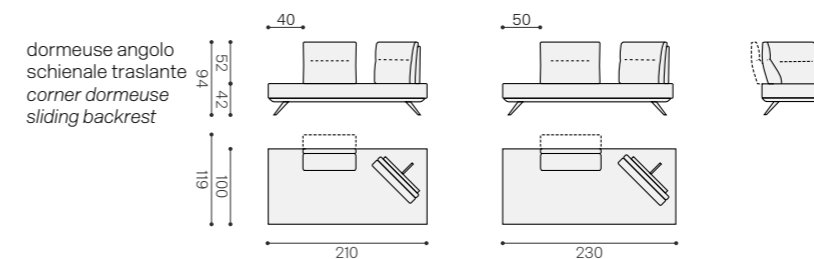
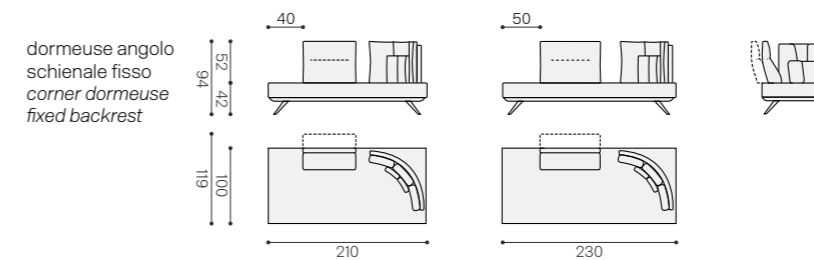
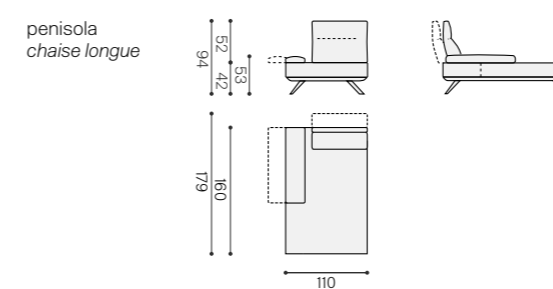
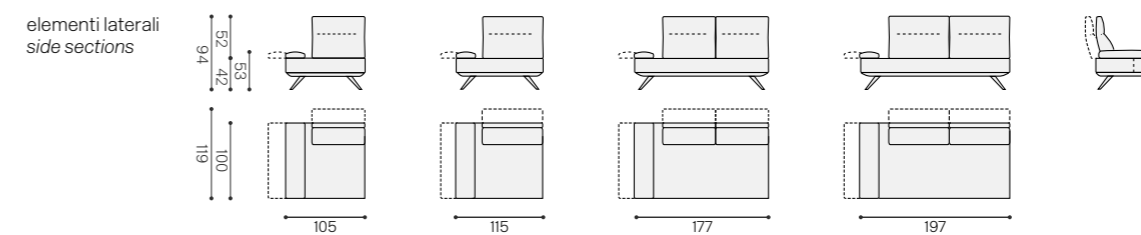
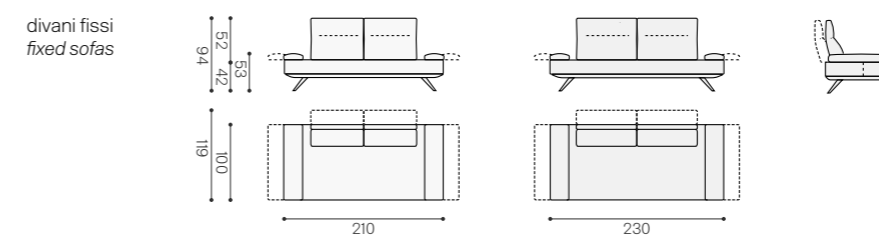

ballarò low

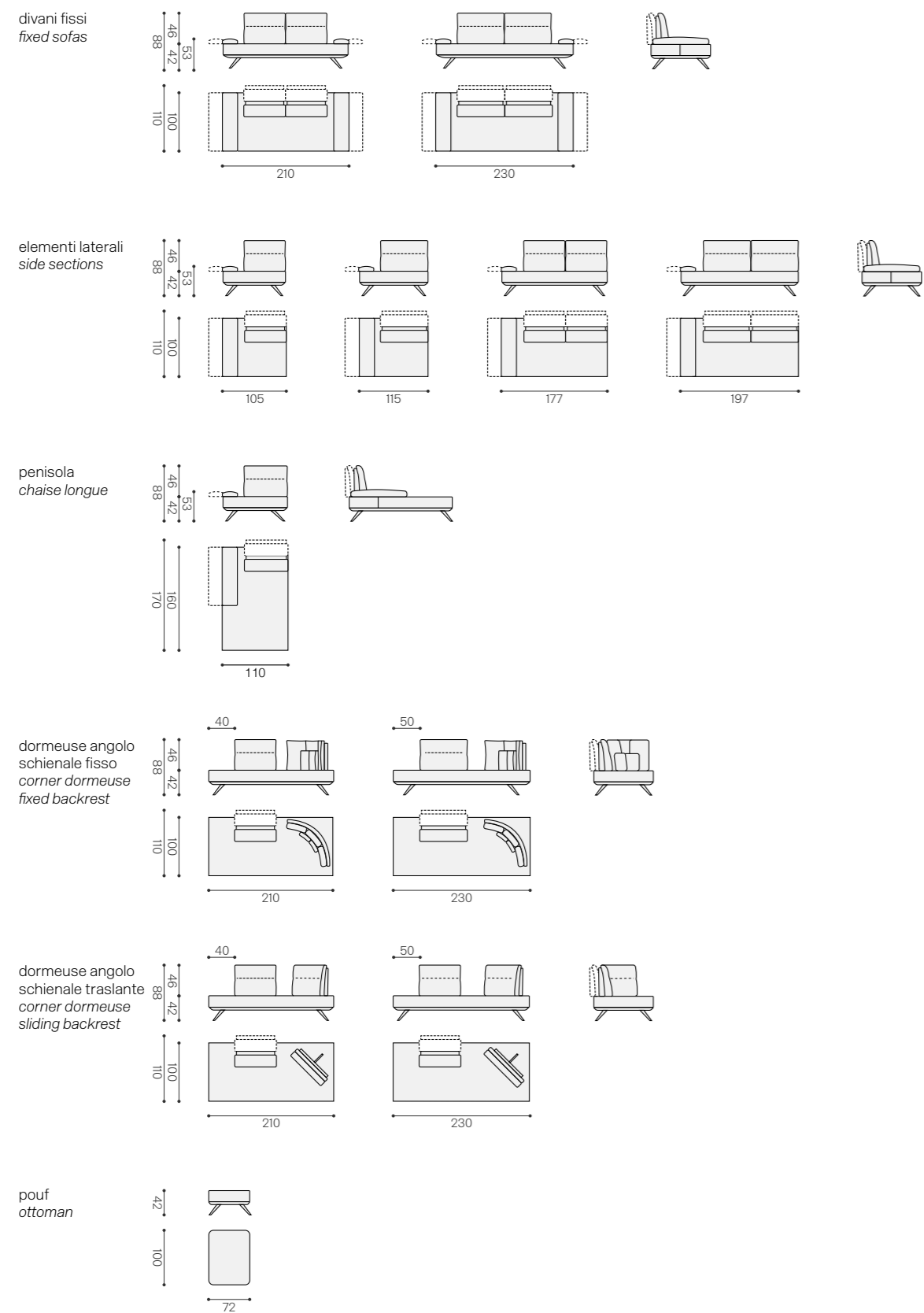

drive

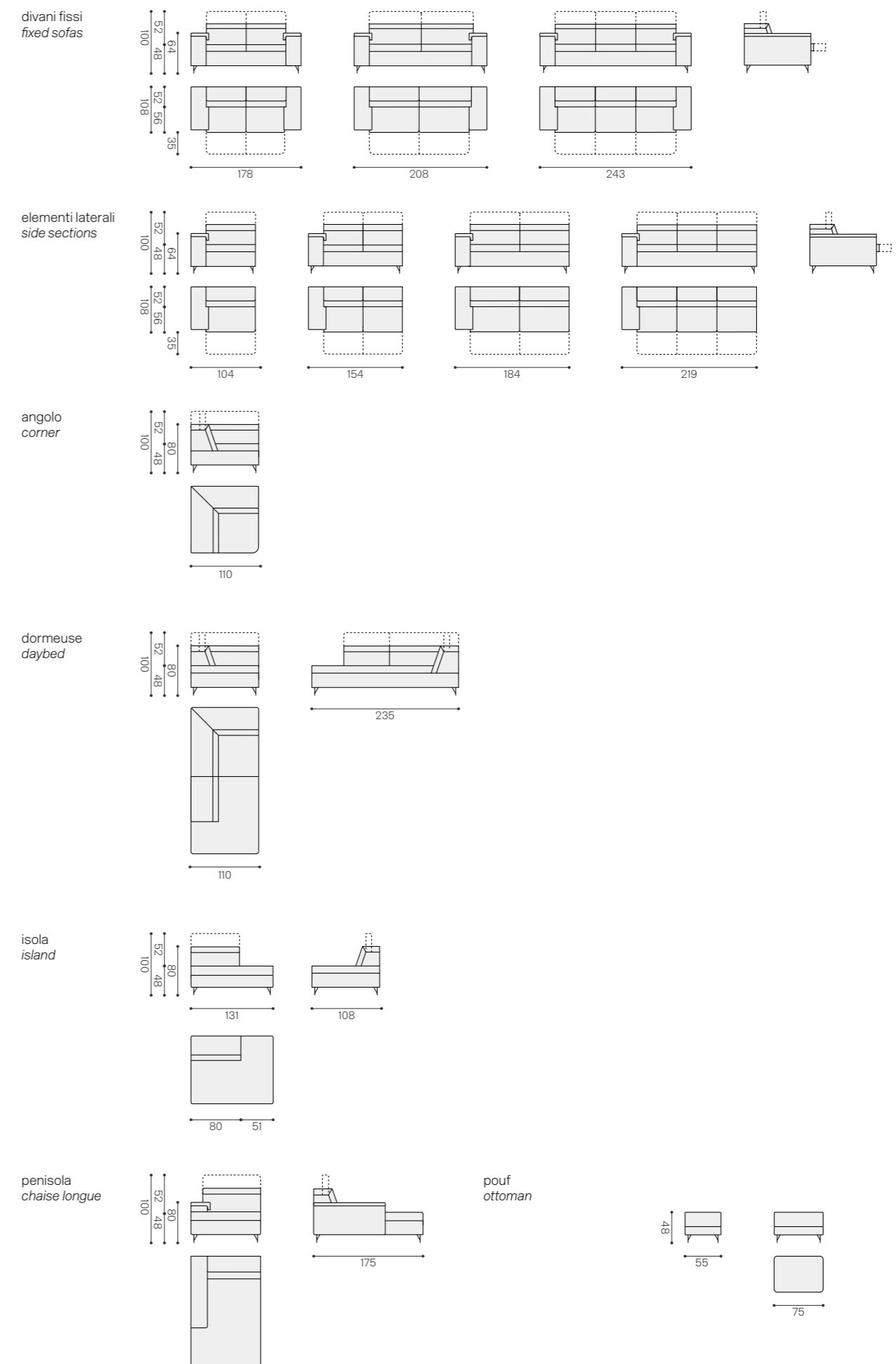

roll-plaz

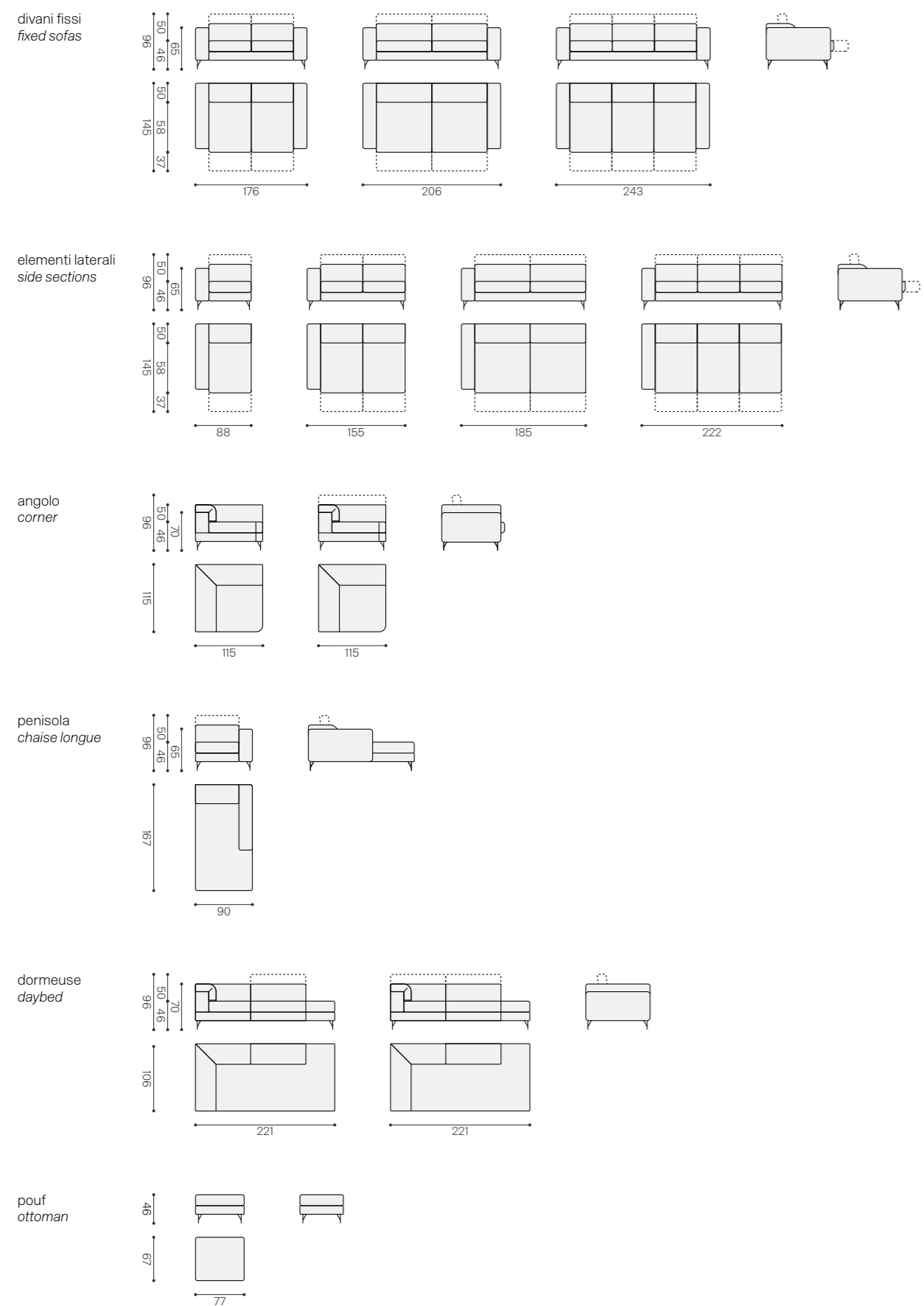

nest

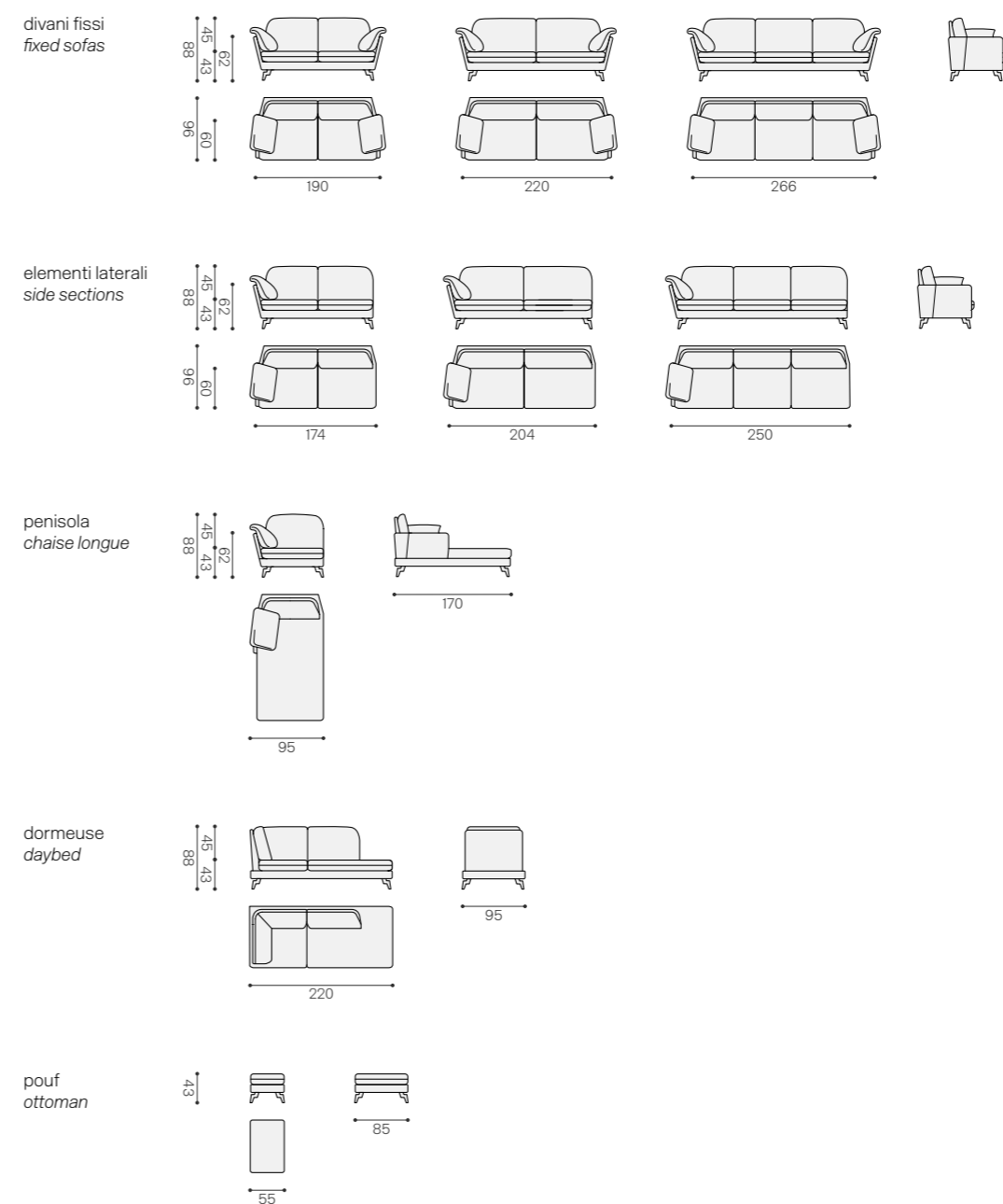

sistema

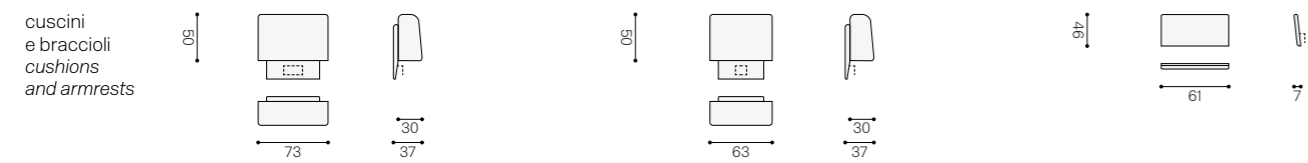
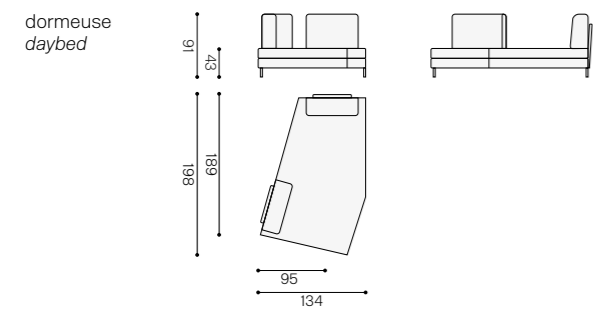
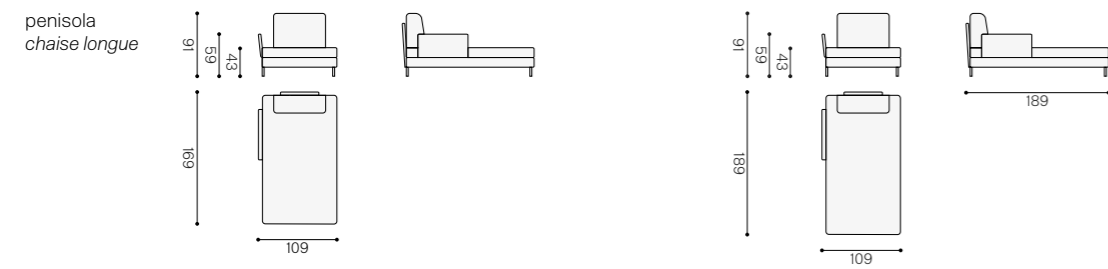
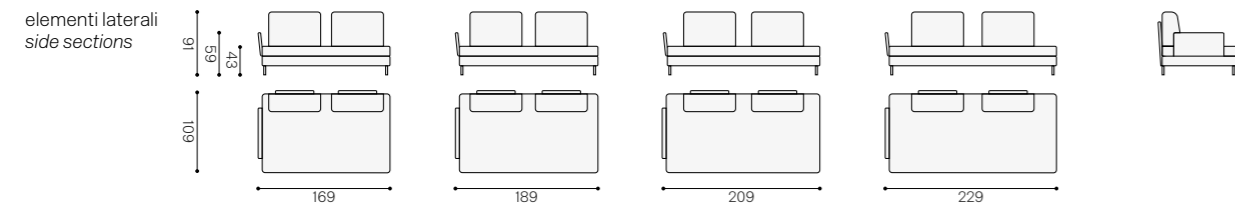
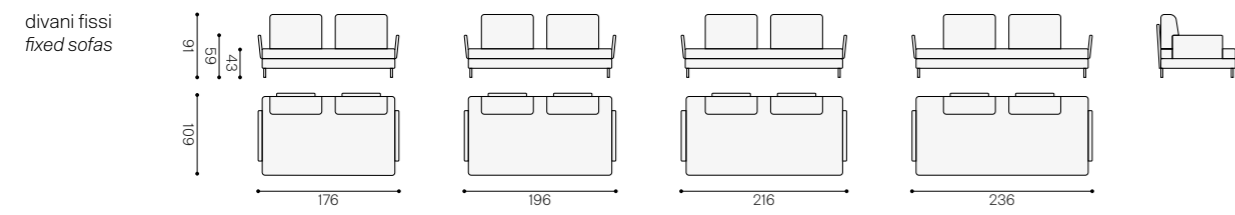

soffy

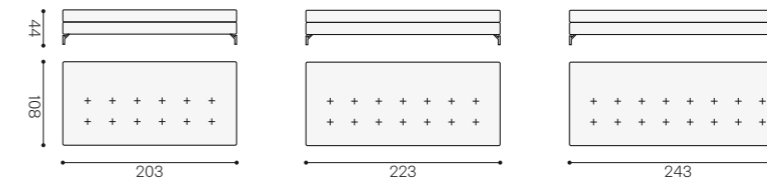
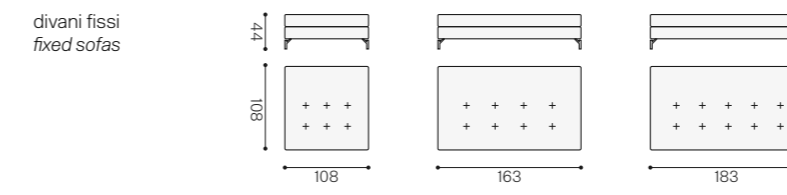

schienali e cuscini
backrests and cushions

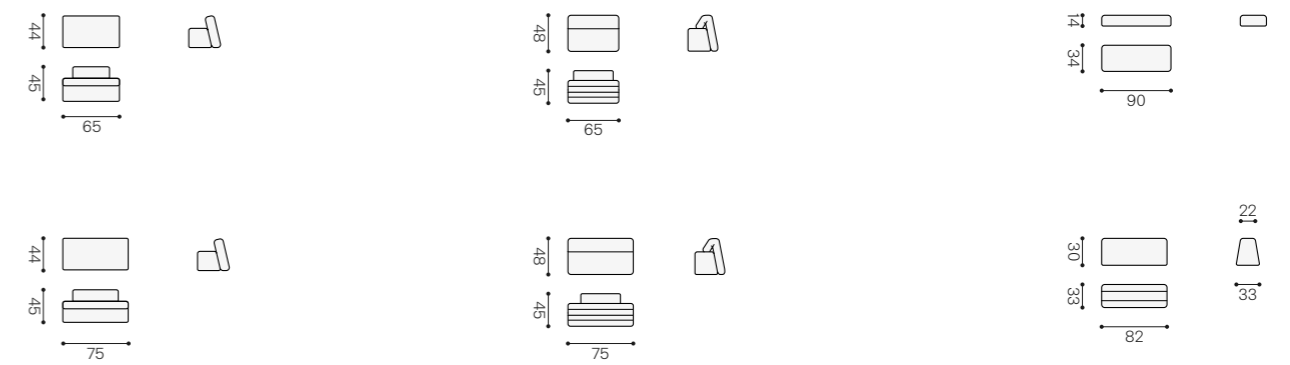

nemo

divani fissi
fixed sofas

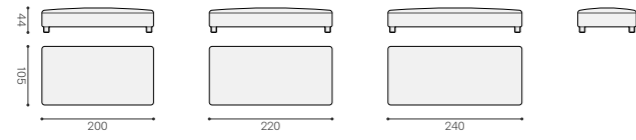
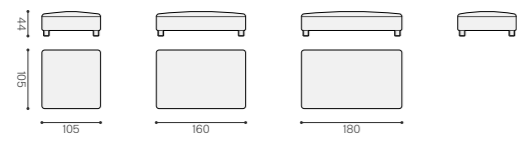

schienali e cuscini
*backrests
and cushions*

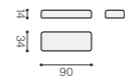
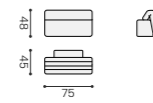
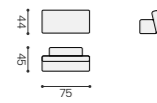
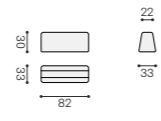
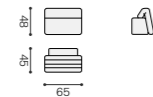

quark

divani fissi
fixed sofas

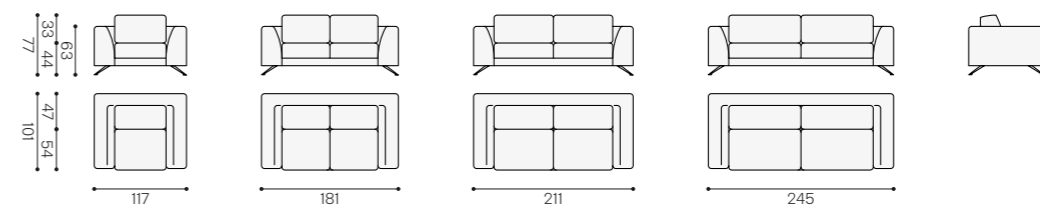

elementi laterali
side sections

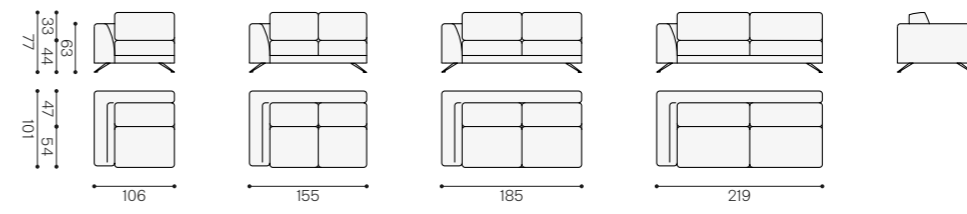

angolo
corner

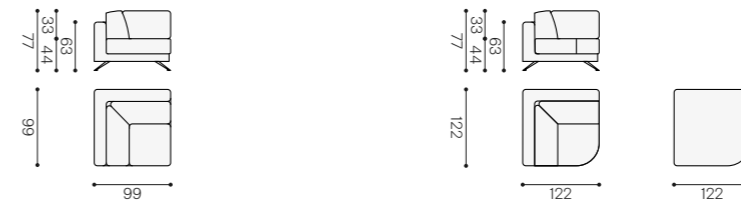

penisola
chaise longue

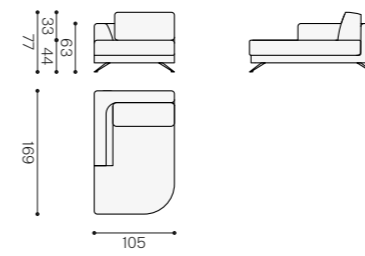

dormeuse
daybed

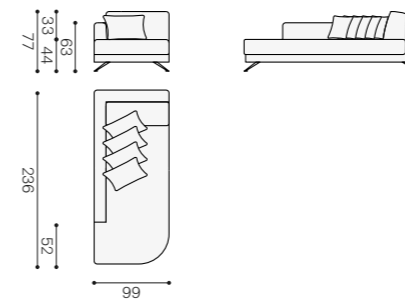

pouf
ottoman

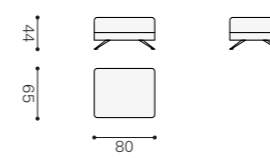

etoile

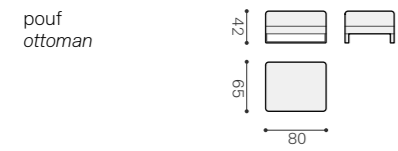
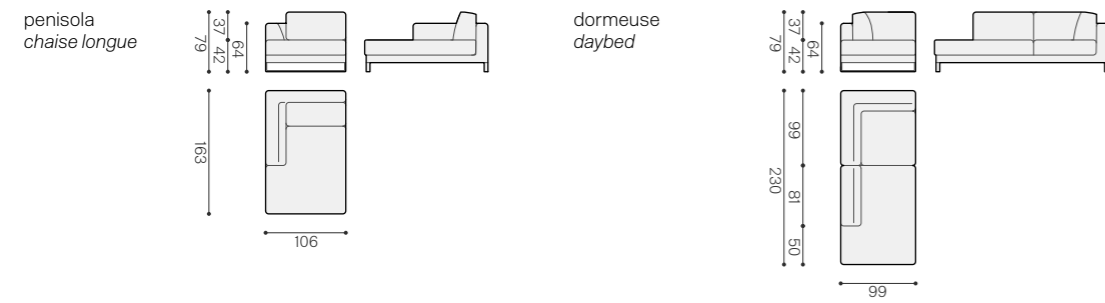
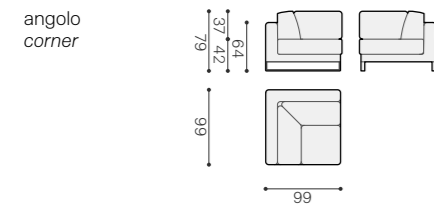
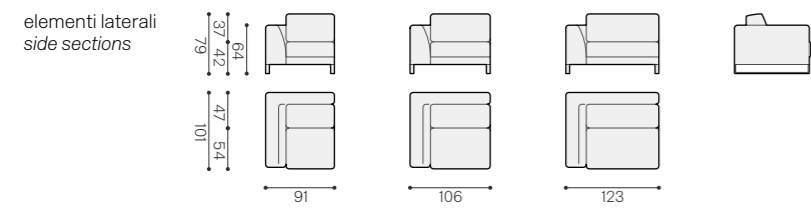
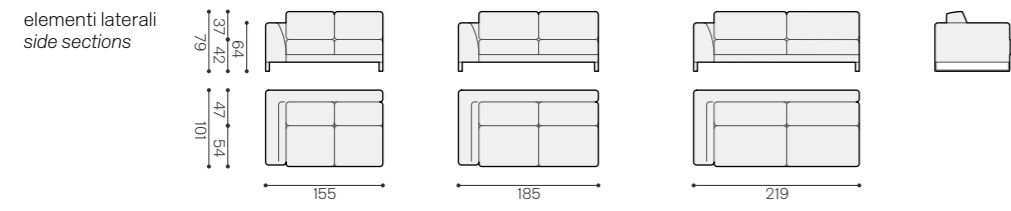
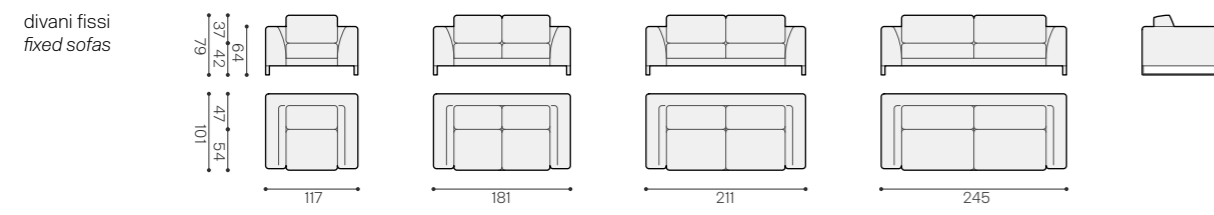

kayo

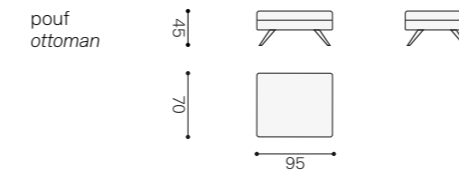
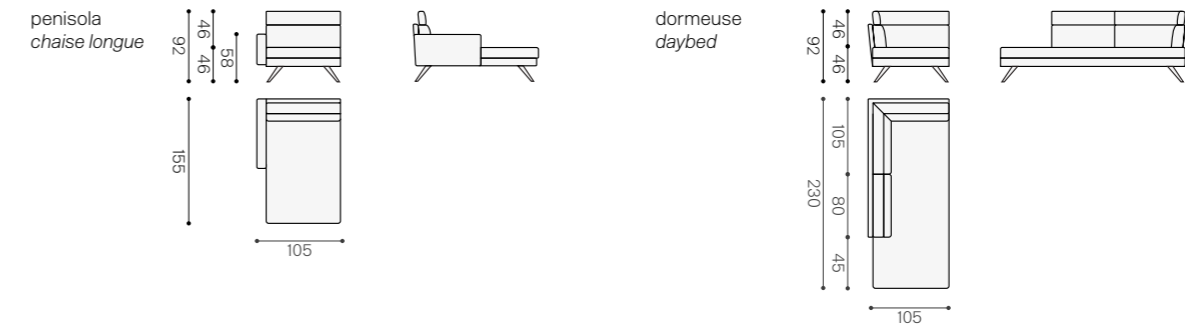
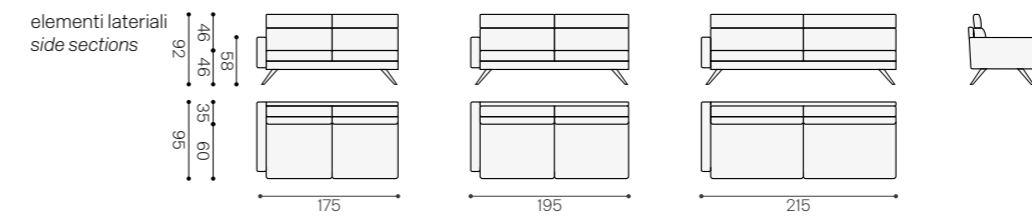
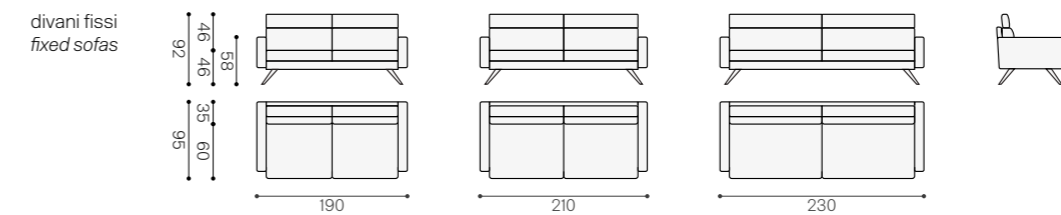

movie

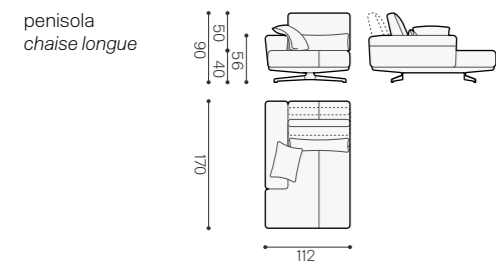
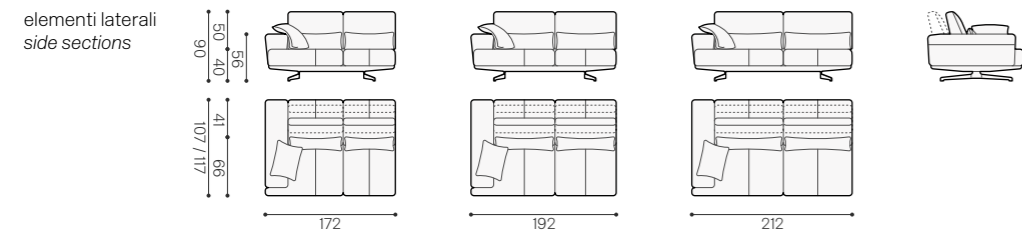
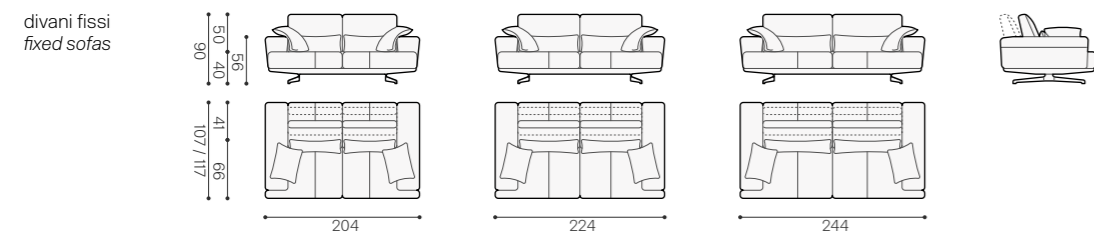

gregor

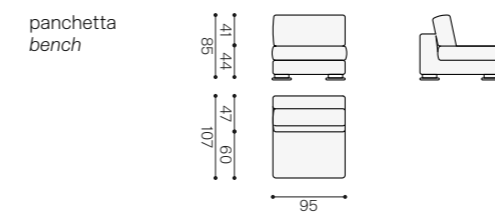
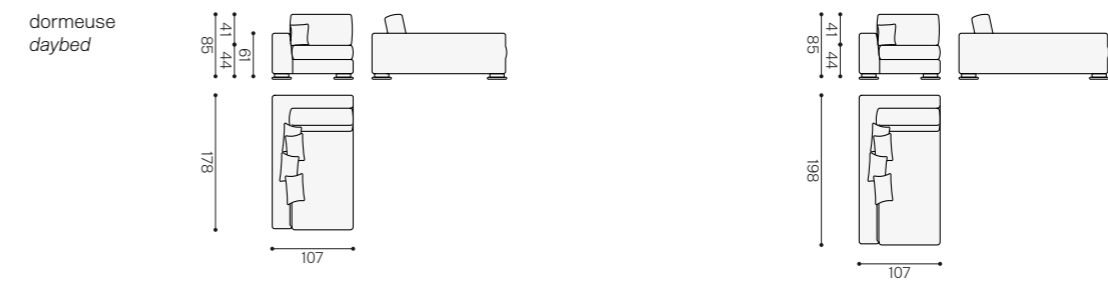
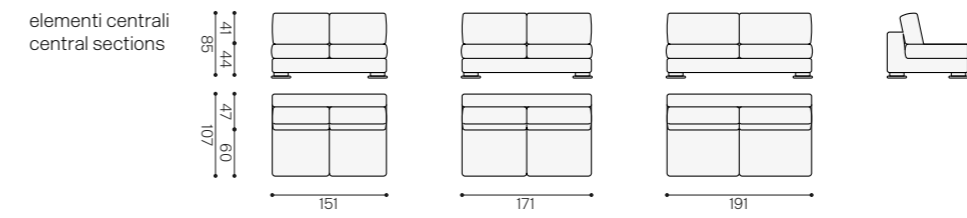
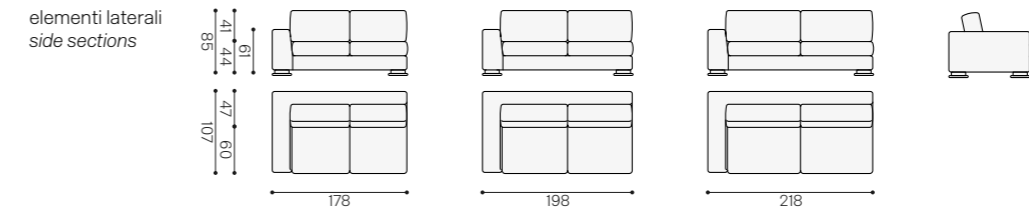
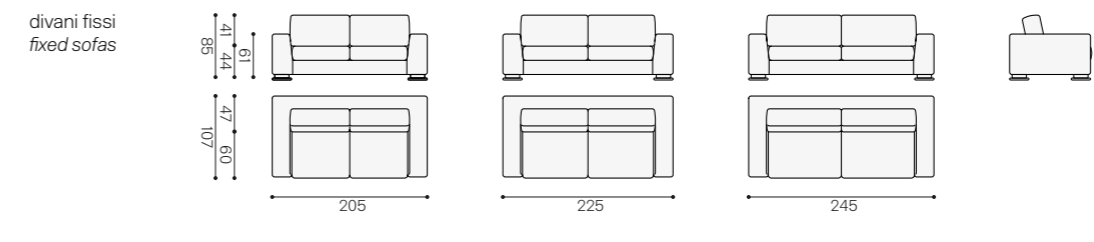

everday

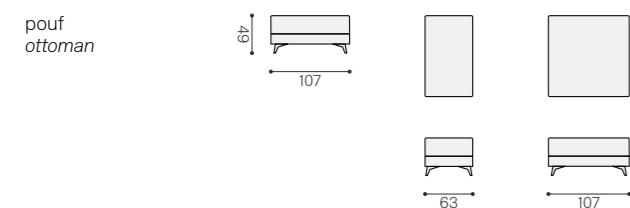
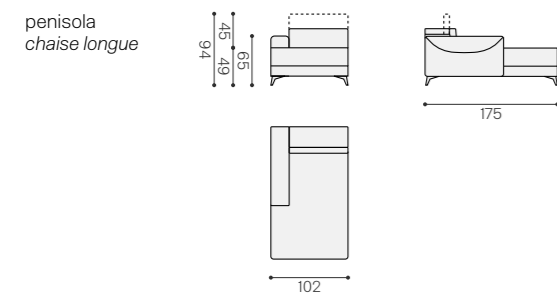
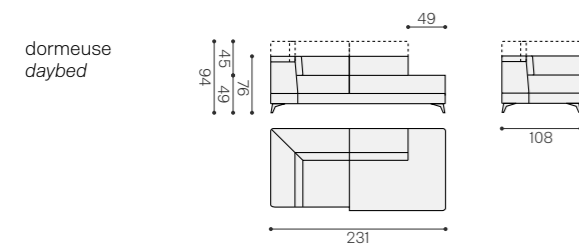
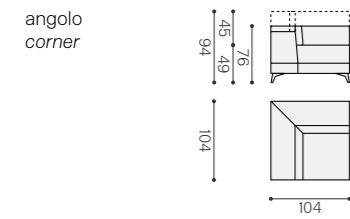
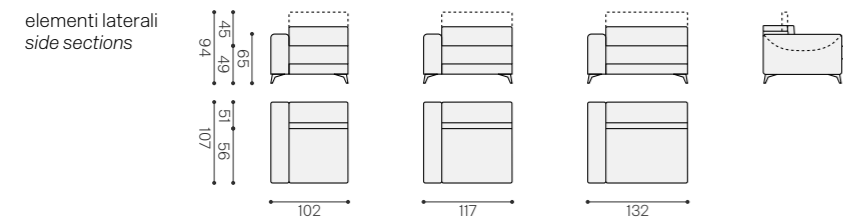
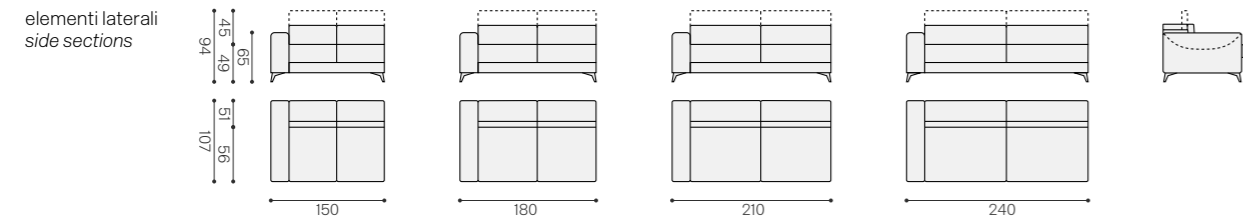
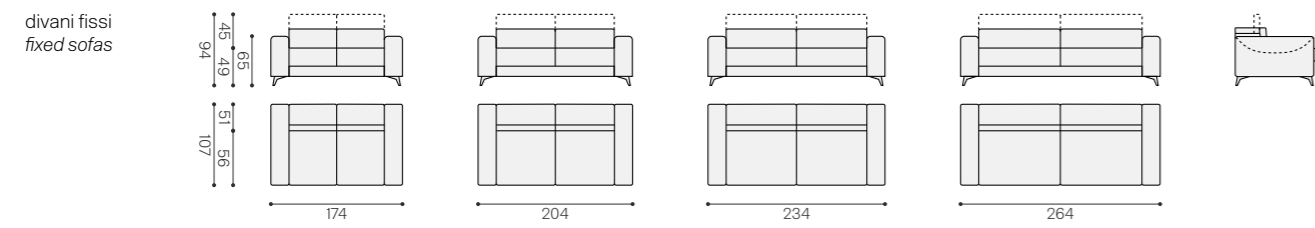

soleil

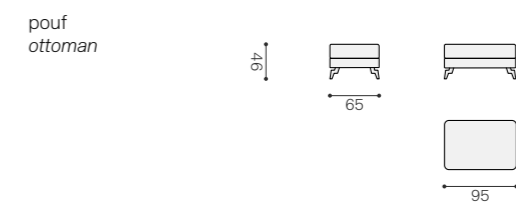
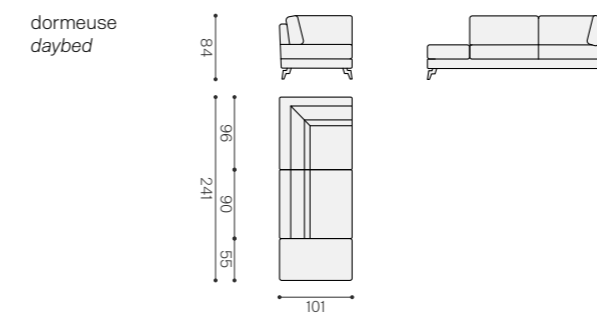
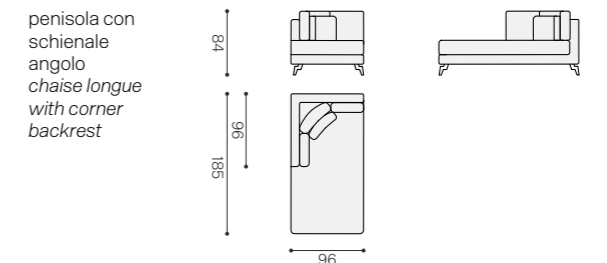
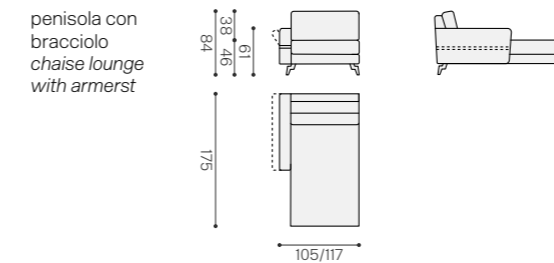
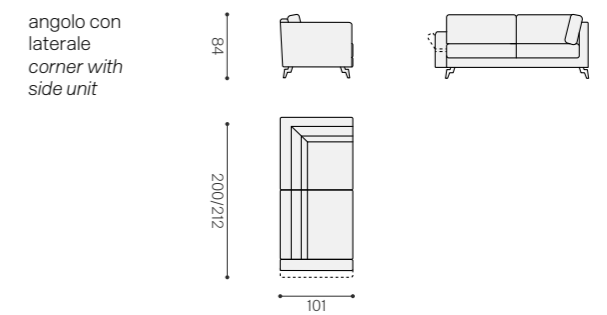
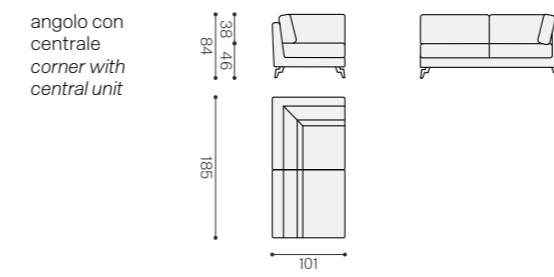
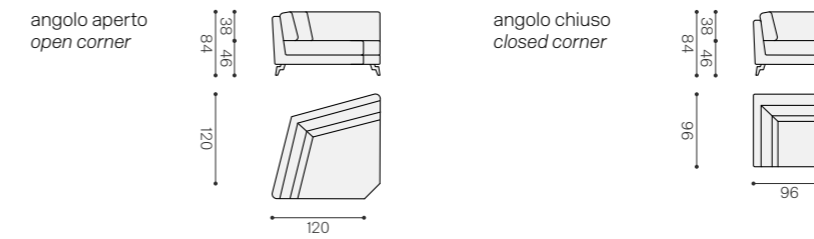
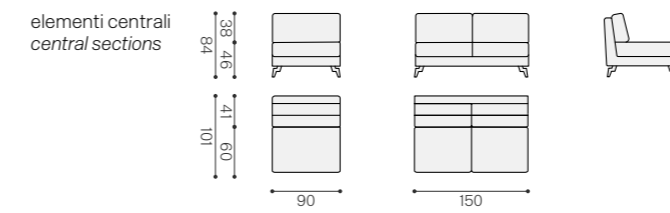
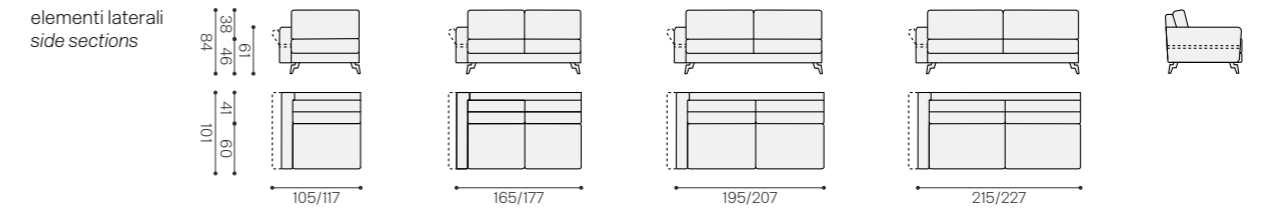
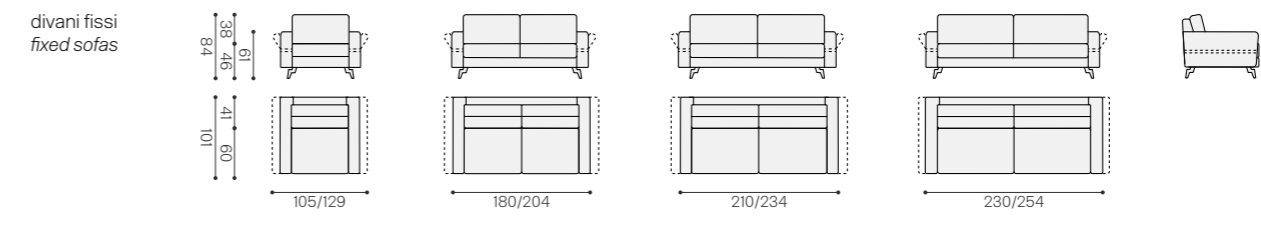

airo

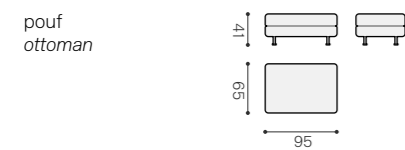
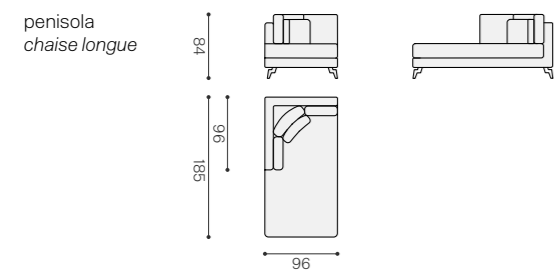
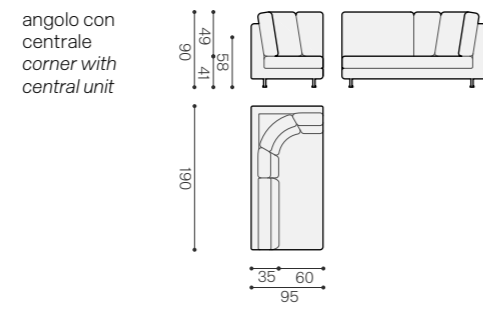
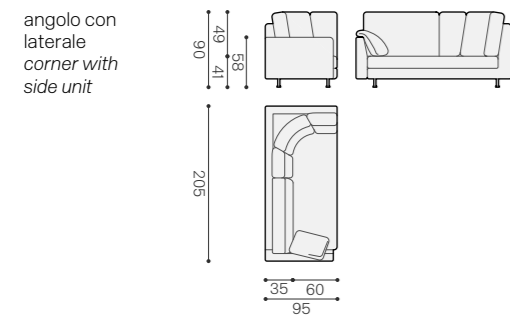
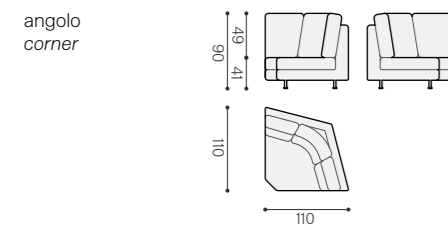
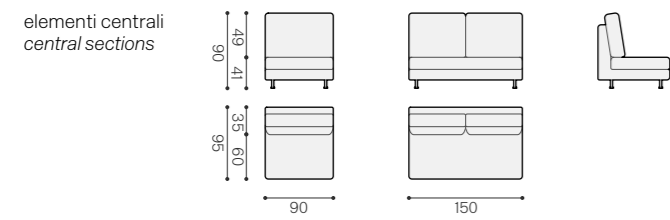
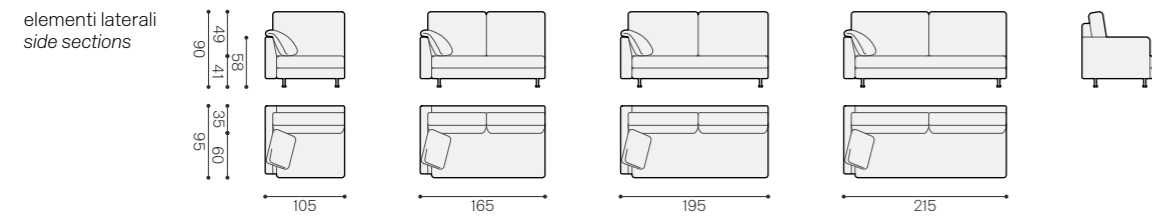
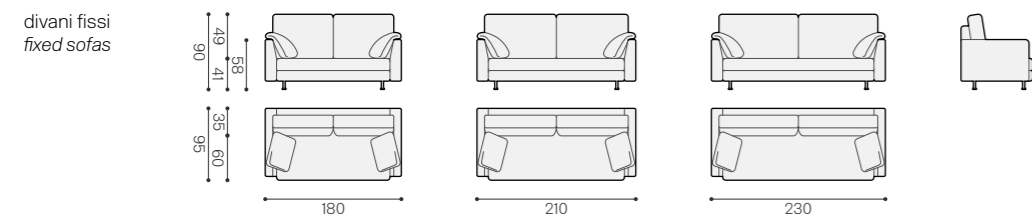

santos

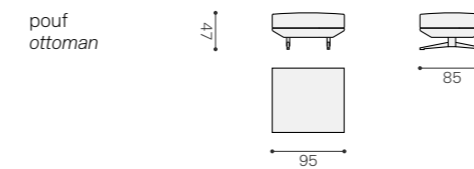
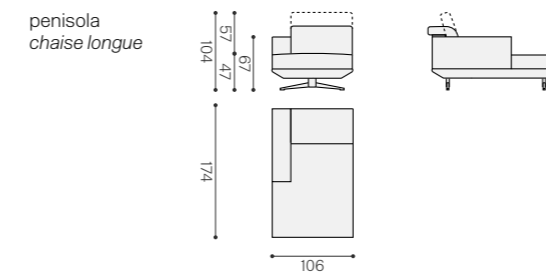
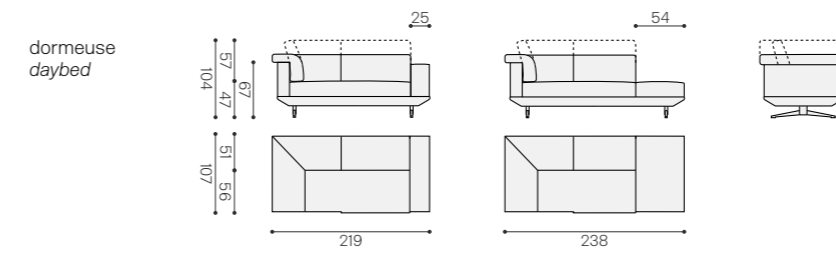
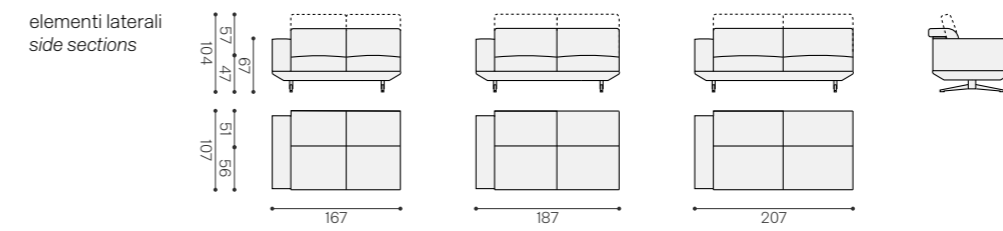
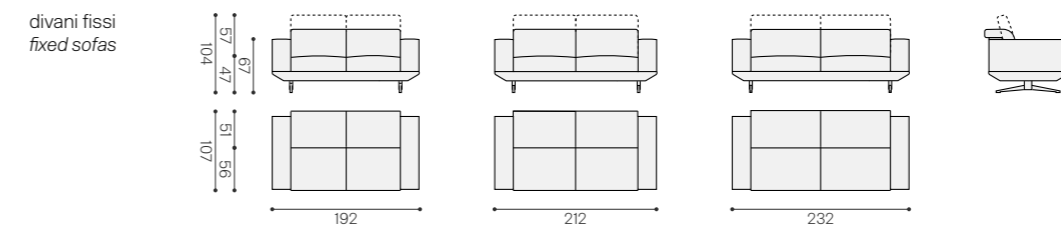

green

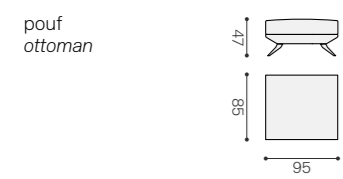
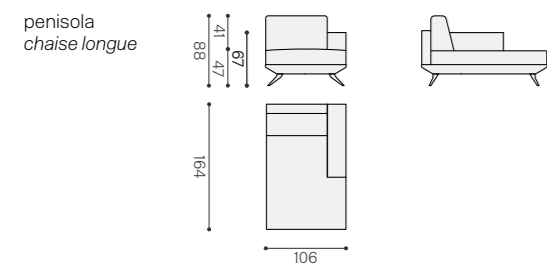
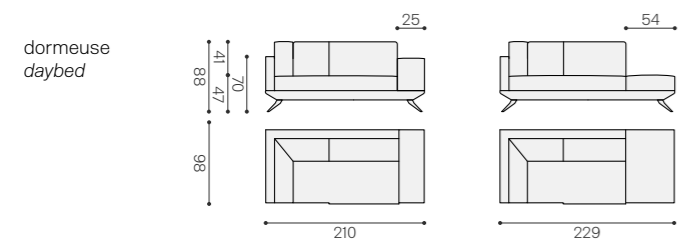
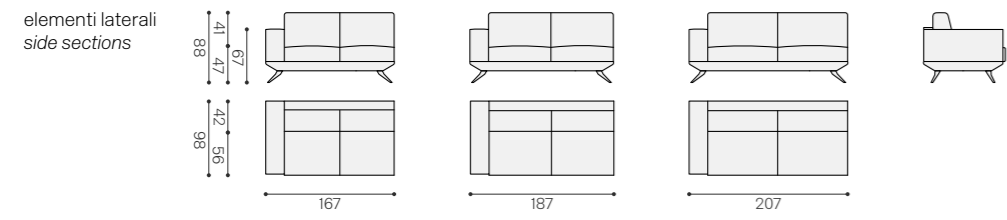
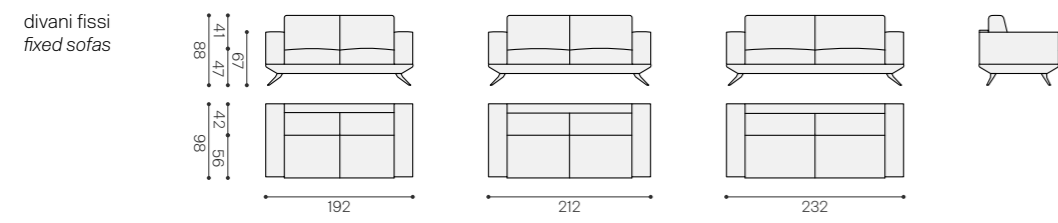

capohorn

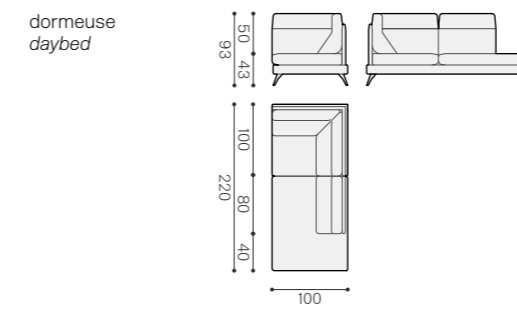
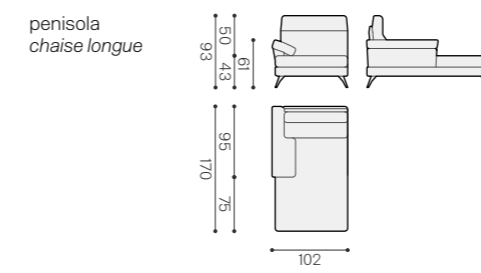
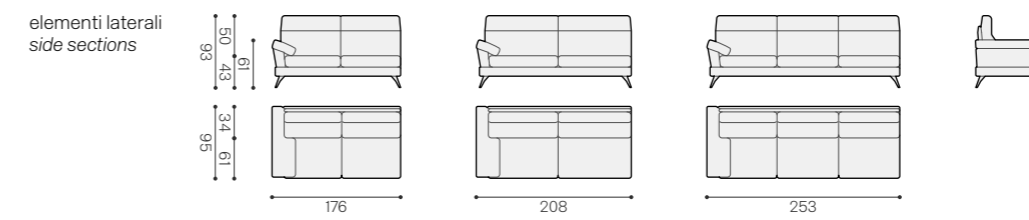
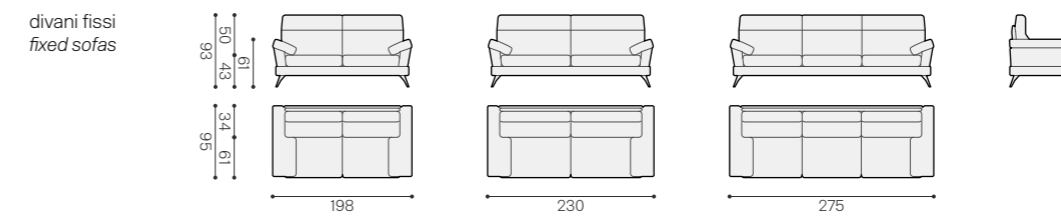

oceano

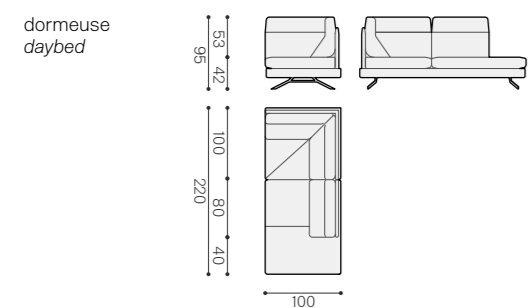
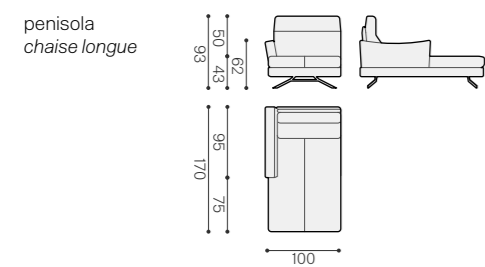
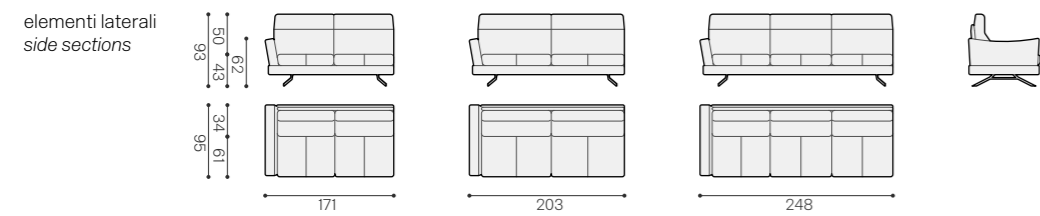
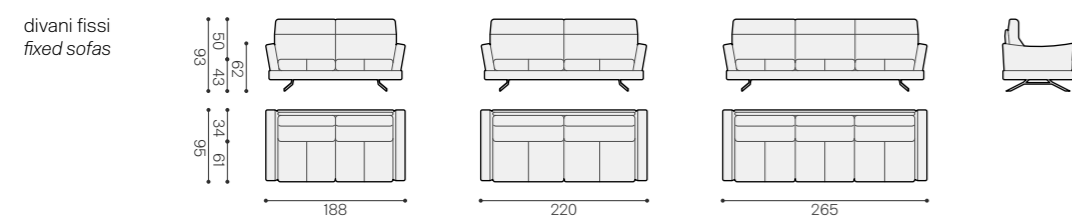

sintesi

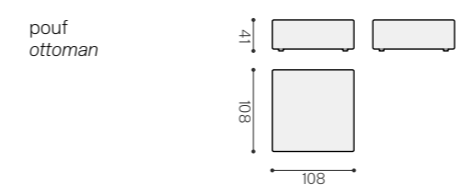
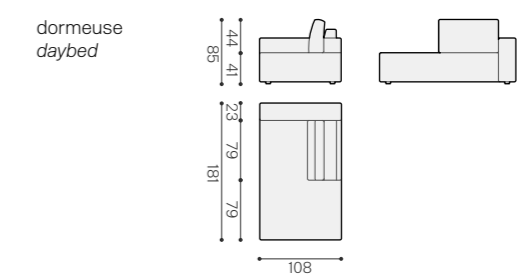
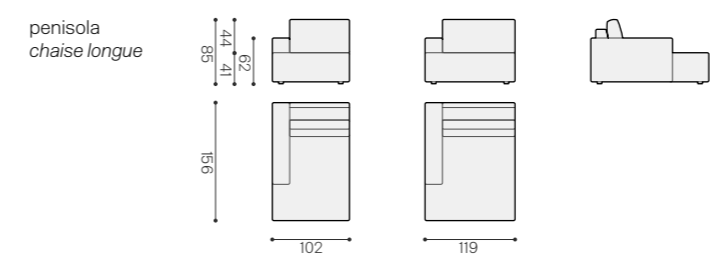
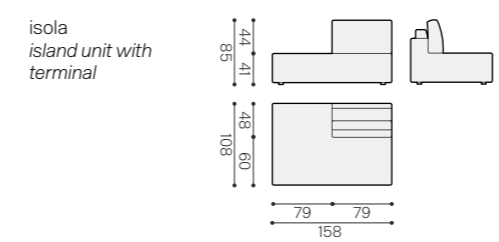
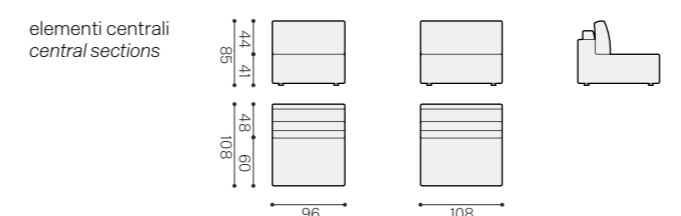
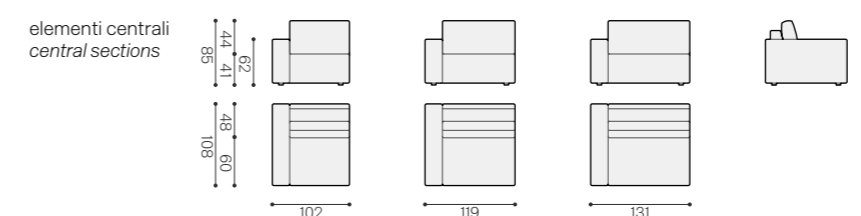
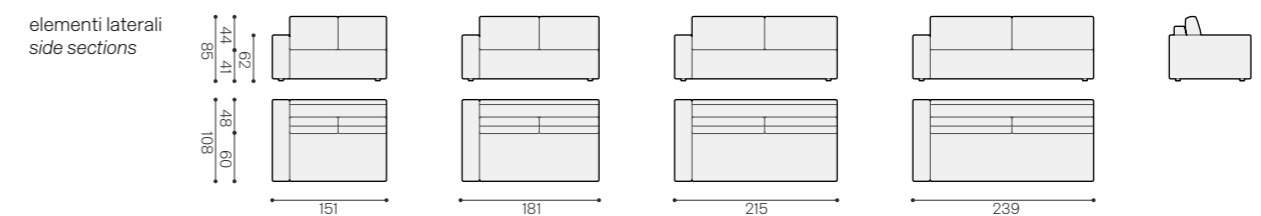
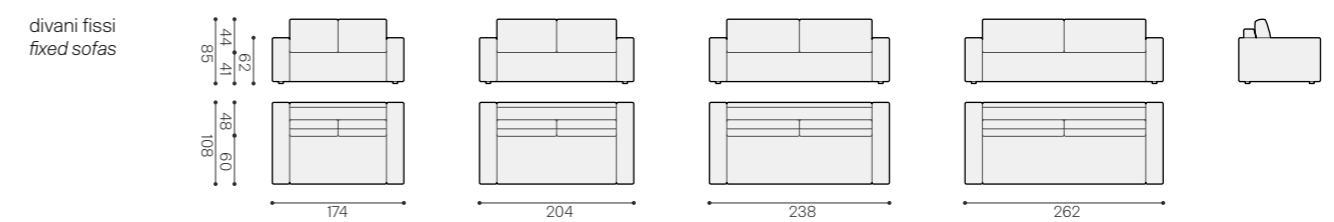



divani | sofa

Moderno

avalon

Un divano dalle forme morbide e dal design essenziale è caratterizzato da ampie sedute, che avvolgono il corpo in un confortevole abbraccio. Le linee sobrie ed eleganti lo rendono un complemento d'arredo che dona al salotto un aspetto elegante e funzionale.

A sofa with soft shapes and an essential design is characterized by large seats, which envelop the body in a comfortable embrace. The sober and elegant lines make it a piece of furniture that gives the living room an elegant and functional look.







tablet

Un divano componibile molto versatile che, grazie ai diversi elementi disponibili (poltrona, angolo, pouf, penisola e dormeuse), offre molteplici possibilità di personalizzazione. Ogni singolo dettaglio è espressione di design e artigianalità, personalità e stile: come le esili staffe in acciaio cromato o il sistema di sollevamento del poggiatesta a scomparsa totale.

A very versatile modular sofa that, due to the different elements available (armchair, corner section, ottoman, chaise longue and daybed), offers multiple possibilities of personalization. Each detail is synonymous with design and craftsmanship, personality and style: such as the chrome-plated steel brackets or the total retractable headrest lifting system.





I poggiatesta regolabili assicurano un ampio ventaglio di posizioni rispondendo alle diverse esigenze di seduta ed offrendo un confortevole sostegno a spalle e zona cervicale. Oltre a garantire un comfort personalizzato, i poggiatesta indipendenti creano anche geometrie diverse, modificando la percezione estetica e formale dello spazio circostante.

The adjustable headrests ensure utmost relaxation in a variety of positions, offering a comfortable support for shoulders and head. Moreover, the separate headrests not only guarantee customized comfort, but also create different geometries, thus modifying the aesthetic and formal perception of the environment.





Il rivestimento in tessuto resiste allo scorrere del tempo, acquisendo sfumature e particolari unici ed irripetibili. Disponibile anche con rivestimento in microfibra in diverse sfumature, anche senza trapuntatura.

The soft fabric covering stands the test of time and acquires unique tones and matchless details. Tablet is also available with microfiber coverings in different colors, also without thick relief stitching.



tylor



Che la parola d'ordine di questo divano componibile dalle forme importanti e generose sia comfort è evidente in ogni particolare: dalle sedute profonde e accoglienti ai braccioli ampi e confortevoli, dai poggiatesta regolabili ai morbidi cuscini salva-reni. Comodità che qui si sposa con design ed eleganza.

Comfort is the watchword of this modular sofa, characterized by cozy and generous shapes. It's clear in every detail: from the deep and welcoming seats to the wide and comfortable armrests, from the adjustable headrests to the soft lumbar pillows. Comfort combines here with design and elegance.



L'ineguagliabile qualità dei rivestimenti, lavorati con grande maestria dai nostri artigiani, si unisce a soluzioni tecniche in grado di esaltare al massimo il comfort. Come il sistema di sollevamento dei poggiatesta e dei braccioli con movimento a cricchetto o la soluzione per la regolazione dei braccioli. Tutto in Tylor è pensato per garantire il massimo relax.

The unrivaled quality of the coverings, resulted by the great care of our artisans, is combined here with useful technical solutions able to increase the feeling of comfort. Such as the headrest and armrests lifting system with ratchet movement or the adjusting solution on the armrests. Everything in Tylor is designed to satisfy the most demanding requirement.





I poggiatesta regolabili assicurano un ampio ventaglio di posizioni rispondendo alle più diverse esigenze di seduta ed offrendo un confortevole sostegno a spalle e zona cervicale. Oltre ad offrire un comfort personalizzato, i poggiatesta indipendenti creano anche geometrie diverse, modificando la percezione estetica e formale dello spazio circostante.

The adjustable headrests ensure utmost relaxation in a variety of positions, offering a comfortable support for shoulders and head. Moreover, the separate headrests not only offer customized comfort, but also create different geometries, thus modifying the aesthetic and formal perception of the environment.



Un divano dai mille volti che trova nella versione con chaise longue o dormeuse il massimo della funzionalità, ma che anche nella soluzione stand-alone è in grado di offrire spazi equilibrati e accoglienti, dove trascorrere il tempo libero in completo relax.

A sofa with several personalities that, in the version with chaise longue or daybed, offer the maximum functionality, but also in the stand-alone solution is able to guarantee balanced and cozy spaces, where you can easily spend your free time in complete relaxation.

volaria

Un sistema modulare di grande effetto dai volumi importanti e ben definiti.
Le forme essenziali, asciutte e squadrate di Volaria vengono alleggerite dai piedini
in metallo cromato, disponibili in più versioni.

*A highly impressive modular system with important volumes and well-defined proportions.
The essential, severe and squared shapes of Volaria are lightened by the chromed metal
feet, available in different versions.*







Volaria è un sistema modulare dinamico, caratterizzato da rivestimenti di alta qualità e finiture impeccabili, nel quale i diversi elementi disponibili creano accoglienti spazi di convivialità, dove trascorrere il tempo in compagnia degli amici, leggendo un libro o ascoltando musica.

Volaria is a dynamic modular system, characterized by high quality coverings and perfect finishes, in which the different elements available create welcoming spaces, where is a pleasure to spend time with friends, reading a book or listening the music.



yoao



Un divano dalle forme compatte e dai volumi importanti, braccioli impreziositi da cuciture che ne evidenziano rigore e pulizia estetica. Yoao si adatta con disinvoltura a qualunque tipologia di arredo e a tutti gli spazi grazie all'ampia componibilità.

A sofa with compact shapes and important volumes, armrests embellished with seams that highlight rigor and aesthetic cleanliness. Yoao easily adapts to any type of furniture and any space thanks to its wide modularity.



Yoao è completamente sfoderabile e adatto a chi predilige uno schienale alto dove poter appoggiare schiena e testa al fine di ottenere il massimo relax.

Yoao has completely removable covers and is suitable for those who prefer a high backrest where they can rest their back and head in order to achieve maximum relax.



Salotto composto da laterale 3 posti piccolo da 197 cm abbinato alla dormeuse da 102x242 cm, con piede in acciaio cromato lucido.

Living room composed of a 197 cm small 3-seater sideboard combined with the 102x242 cm day bed, with anthracite painted metal foot.

astro

Astro con i suoi morbidi volumi trasforma l'eleganza in comodità. Un divano dai tratti forti e decisi che, grazie alle avvolgenti cuscinate, diventa un elemento d'arredo tutto da vivere.

Astro with its soft volumes transforms elegance into comfort. A sofa with strong and decisive features that, thanks to the enveloping cushions, becomes a piece of furniture to be experienced.







Divano caratterizzato dalla particolarità del bracciolo che con la sua forma voluminosa e l'imbottitura generosa, permette una seduta all'insegna del massimo confort.

Sofa characterized by the peculiarity of the armrest which, with its voluminous shape and generous padding, allows for a seat in the name of maximum comfort.

Astro è configurabile sia in versione bloccata che componibile, con la possibilità di aggiungere uno o più elementi penisola.

Astro can be configured in both the blocked and modular versions, with the possibility of adding one or more chaise longue elements.



feni SI

Feni SI è il divano componibile caratterizzato da sedute uniche, ampie e confortevoli, le linee essenziali e nette dei suoi volumi lasciano spazio a morbidi schienali in piuma. Un divano dall'ampia e versatile modularità.

Feni SI is the modular sofa characterized by unique, large and comfortable seats, essential lines and its clear volumes leave room for soft feather backs. A sofa with a wide and versatile modularity.







feni SD

Pulizia formale ed estetica per il divano Feni SD, caratterizzato da pratiche sedute divise. Un volume puro in cui i braccioli divengono tutt'uno con la struttura, incorniciando sedute e schienali per un perfetto comfort.

Formal and aesthetic cleanliness for the Feni SD sofa, characterized by practical divided seats. A pure volume in which the armrests become one with the structure, framing the seats and backrests for perfect comfort.





kommodo



Protagonisti di questo divano dal design intramontabile sono gli schienali: alti, indipendenti, flessibili e con funzione poggiatesta. I voluminosi cuscini con poggiatesta imbottito sdrammatizzano le rigorose geometrie esaltando il piacere del relax.

Backrests are the protagonists of this timeless sofa: high, independent, flexible and with a headrest function. The bulky cushions with upholstered headrest smooth the rigorous geometrical shapes thus emphasizing the pleasure of comfort.



Disponibile in diverse versioni, grazie ai numerosi elementi componibili (laterale, penisola, angolo, pouf), Kommodo è in grado, in ogni versione, di soddisfare al meglio le più diverse esigenze di comfort.

Kommodo is able to satisfy the most demanding necessity of comfort in the stand-alone version as well as with chaise longue or with the several elements available (side sections, corner, ottoman).





soft



Non potrebbe esserci nome più calzante di Soft per descrivere questo divano moderno dalle forme morbide, accoglienti ed ampie dove viene spontaneo abbandonarsi dopo una giornata di duro lavoro. Un divano incredibilmente comodo che sembra, quasi, voler accogliere il corpo in un soffice abbraccio.

Soft is the perfect name for describing this modern sofa with fluffy, cozy and spacious shapes where it's natural to abandon yourself after a tough day at work. An incredibly comfortable sofa that almost seems to welcome you in a sort of loving embrace.



Per chi desidera uno stile più maturo, senza rinunciare alla confortevole morbidezza di Soft, è possibile optare per la soluzione stand-alone con rivestimento in tessuto bianco, più formale ed elegante.

For those who want a more mature style, without giving up the comfortable softness of Soft, it is possible to opt for the standalone solution with white fabric upholstery, more formal and elegant.



misvago

Forme sobrie ed essenziali che mantengono nel tempo la propria attualità, differenti combinazioni disponibili (poltrona, penisola, poggiatesta contenitore, ecc.), oltre alla possibilità di aggiungere un poggiatesta reclinabile, fanno di Misvago il divano ideale dove rigenerarsi dopo una lunga giornata di lavoro.

Simple and essential shapes that preserve their modernity over time. Different elements available (armchair, chaise longue, storage ottoman, etc.) and the possibility to add a reclining headrest system make Misvago the ideal solution for relaxing after a long day.







Ogni singolo dettaglio qui è studiato per offrire il massimo comfort: dalla morbidezza dei cuscini, voluminosi e in soffice misto-piuma, alla chaise longue dalle dimensioni generose fino al poggiatesta, dotato di un pratico contenitore.

Each detail of Misvago is designed to provide maximum comfort: from the softness of the cushions, voluminous and padded with soft feather, to the cozy chaise longue up to the ottoman, equipped with an useful container.



minimò

Minimò è il divano pensato per le esigenze del vivere contemporaneo, in grado di garantire il massimo comfort con il minimo ingombro. La profondità della seduta, pur essendo ridotta a 70 cm, mantiene uno stile armonico e assolutamente elegante.

Minimò is a modern sofa designed for the needs of contemporary living, able to ensure maximum comfort with minimum size. The seat has been reduced in depth up to 70 cm without compromising the harmonious elegant design.





Minimò è il divano per chi non vuole rinunciare al comfort ma ha uno spazio ridotto per cui cerca un divano poco profondo ma attuale ed elegante.

Minimò is the sofa for those who do not want to give up comfort but have limited space and are therefore looking for a shallow but current and elegant sofa.



king

King è il divano ideale per chi desidera gli schienali alti e dotati di morbidi cuscini laterali d'appoggio che rendono il sofà particolarmente accogliente e comodo. Con profondità ridotta a 80 cm è il divano adatto anche a chi dispone di piccoli spazi e necessita di un elemento di piccole dimensioni.

King is the ideal sofa for those who want high backrests and equipped with soft side cushions that make the sofa particularly welcoming and comfortable. With a depth reduced to 80 cm, it is the sofa also suitable for those who have small spaces and need a small-sized element.





zelig



Comodità e design caratterizzano il salotto Zelig, che sviluppa una vasta gamma di elementi con una profondità minima di 80 cm. Creato per chi cerca una seduta non troppo profonda, ha una linea sobria e accattivante.

Comfort and design characterize the Zelig living room, which develops a vast range of elements with a minimum depth of 80 cm. Created for those looking for a seat that is not too deep, it has a sober and captivating line.



togo

Un prodotto senza tempo adatto a tutti gli ambienti e gli stili, Togo è la perfetta sintesi tra l'essenzialità contemporanea e la preziosità dei dettagli. Un divano funzionale e accogliente, capace di esprimere il proprio carattere deciso anche nelle soluzioni freelance.

A timeless product suitable for every location and styles, Togo is the perfect synthesis between the today's essentiality and the preciousness of details. A functional and cozy sofa, able to express its strong character also in the freelance version.







Elemento distintivo di questo divano è la sagomatura del bracciolo: un invito a lasciarsi andare per goderne appieno il comfort.

A distinctive feature of Togo sofa is the armrests shape: an invitation to sit down and enjoy its unrivalled comfort.



ray's

Grazie al design snello, alle linee moderne, all'infinita modularità delle composizioni e all'essenzialità dei profili, Ray's è il protagonista indiscusso di ogni casa, sia moderna che classica.

Thanks to the slender design, the modern silhouette, the infinite modularity of the elements and the essentiality of the profiles, Ray's is the undisputed protagonist of every environment, both modern and classic.

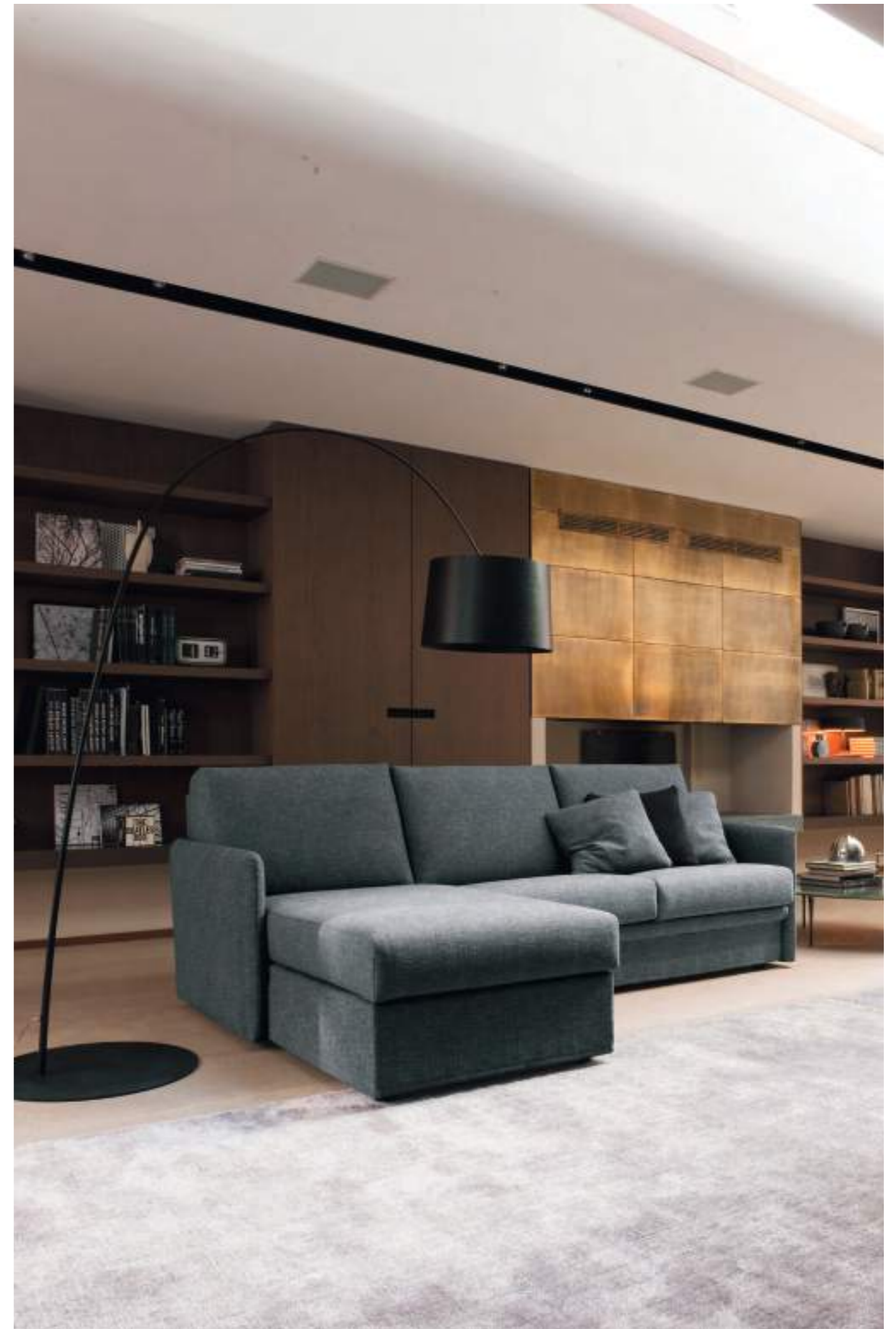





Le versioni con elementi chaise longue sono vere e proprie isole di relax ideali per l'Home Theater, l'ascolto di brani musicali o la lettura. La configurazione a doppia penisola side by side, invece, crea un inedito layout di convivialità dove è spontaneo condividere le proprie passioni.

The chaise longue versions are the perfect solution for watching movies, listening music or reading in complete relaxation. Furthermore, you will be able to share your passions in a completely new and spontaneous way by placing two chaise lounge side by side.





tecnica
technical

avalon

divani fissi
fixed sofas

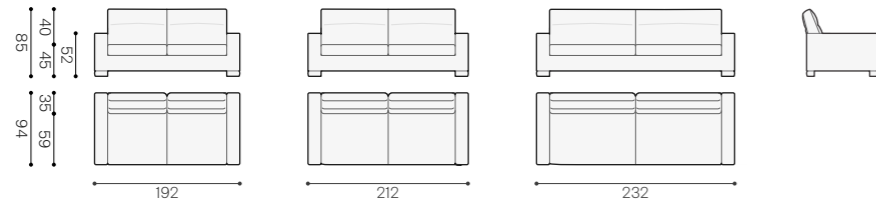

elementi laterali
side sections

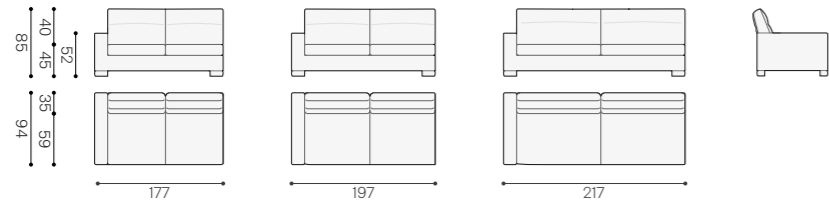

penisola
chaise longue

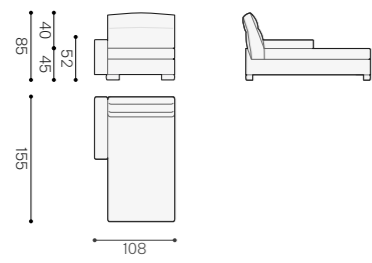

dormeuse
daybed

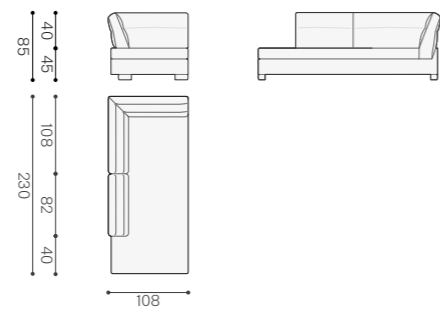

pouf
ottoman

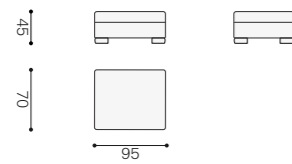

tablet

poltrona
armchair

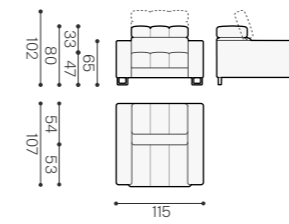

divani fissi
fixed sofas

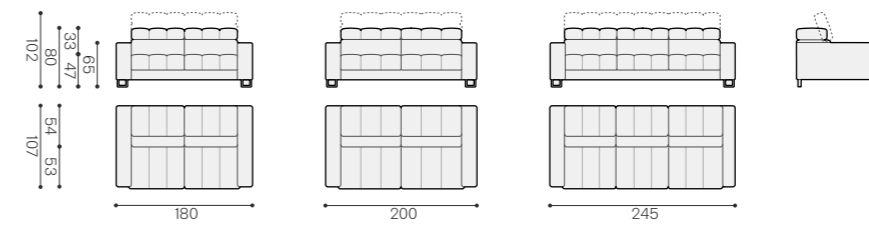

elementi laterali
side sections

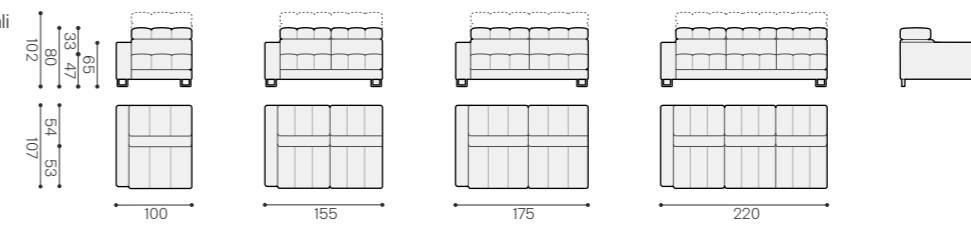

angolo
corner

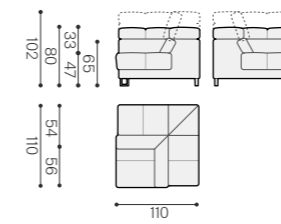

dormeuse
daybed

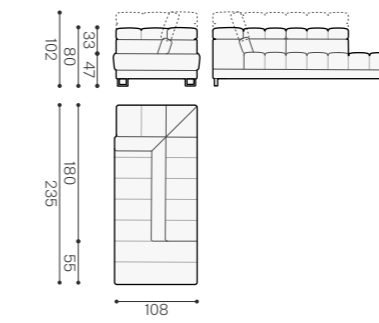

penisola
chaise longue

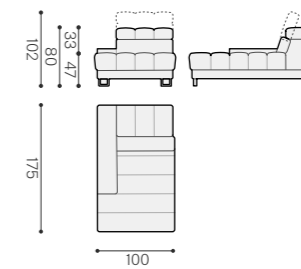

pouf
ottoman

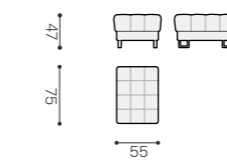

tylor

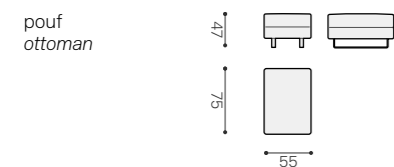
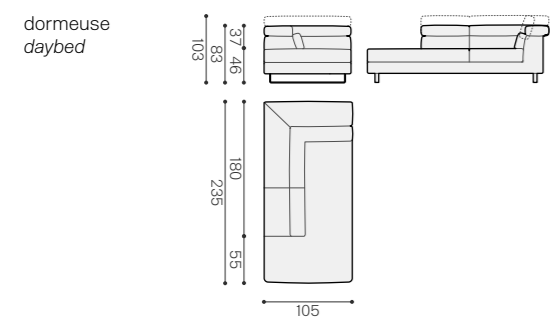
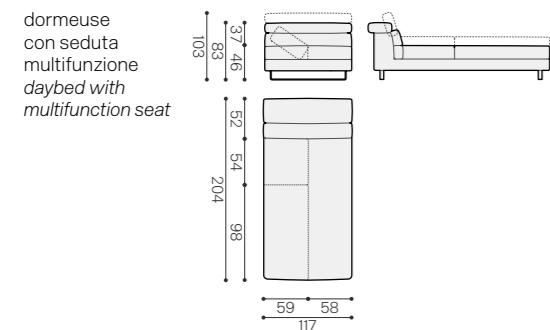
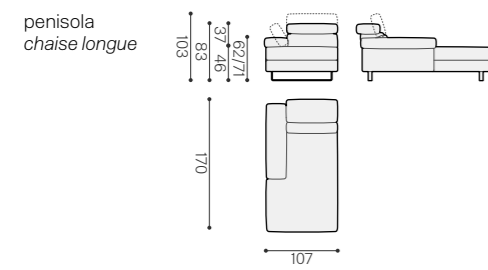
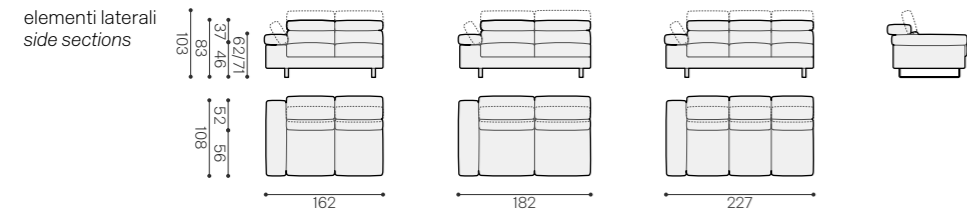
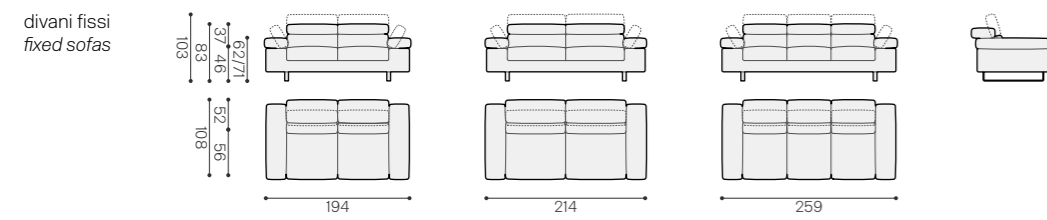

volaria

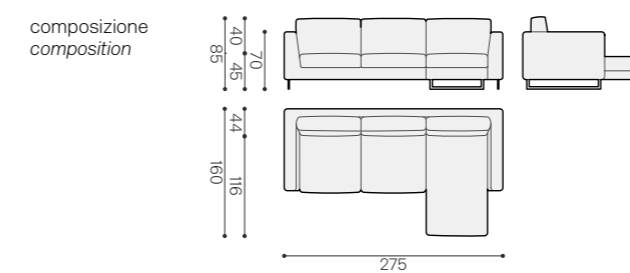
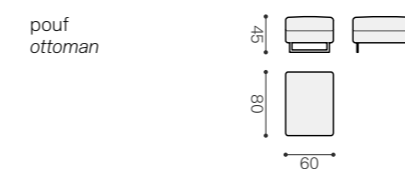
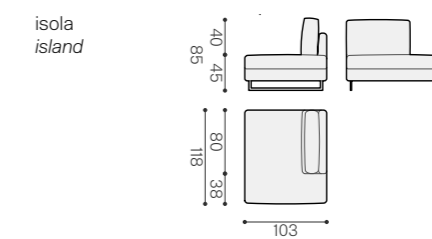
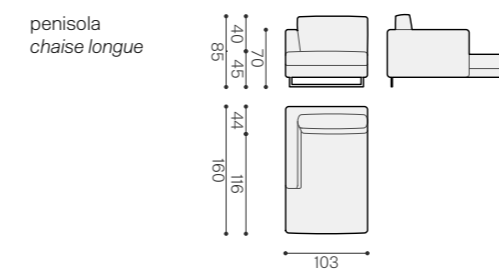
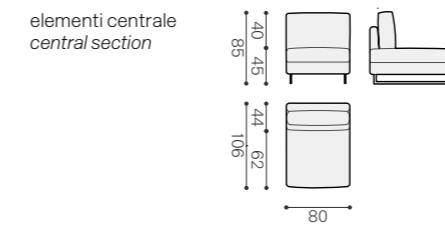
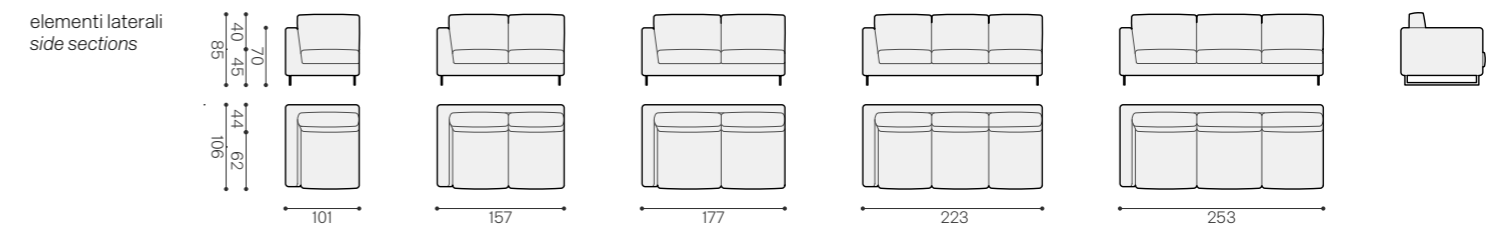
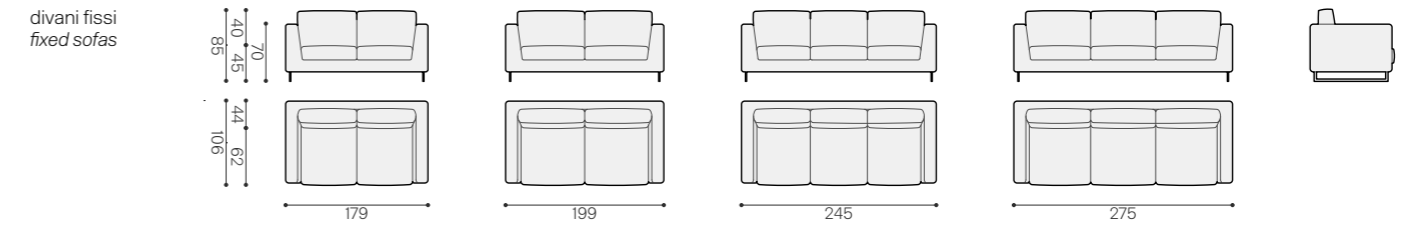
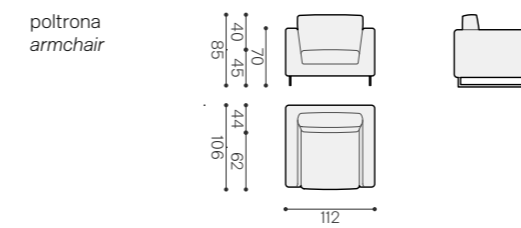

yoao

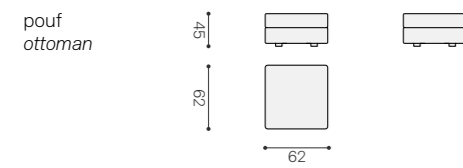
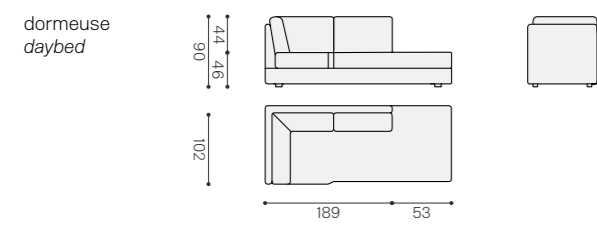
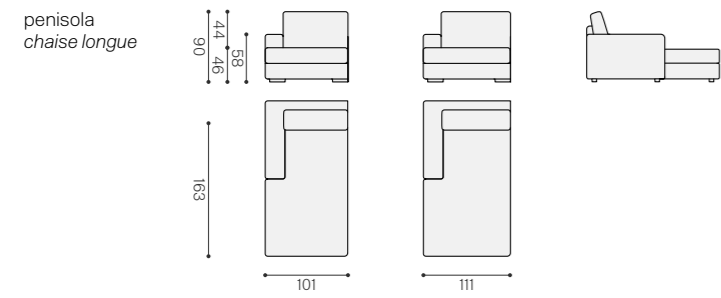
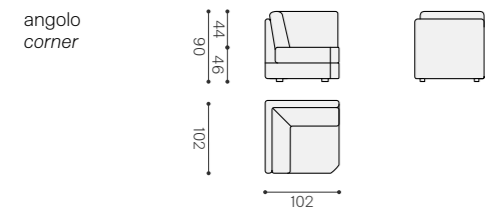
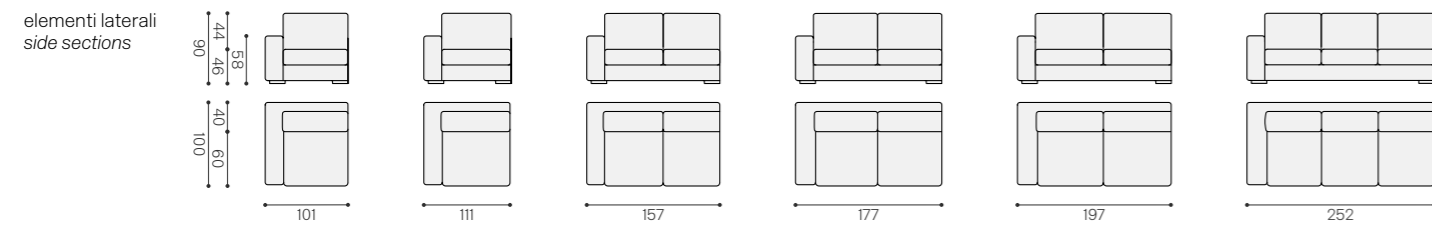
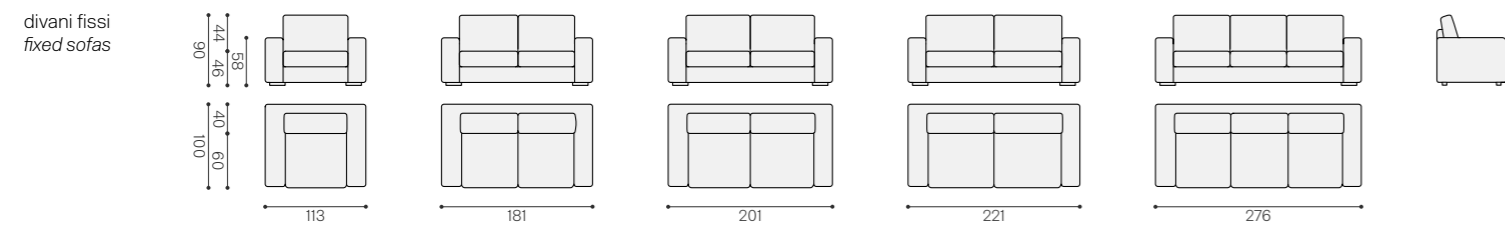

astro

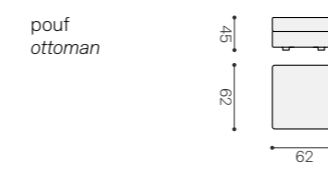
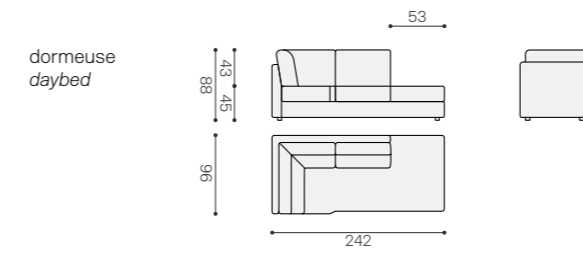
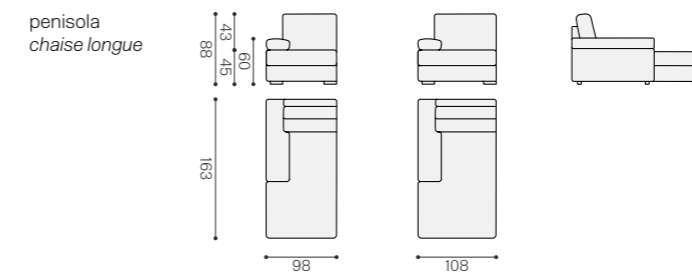
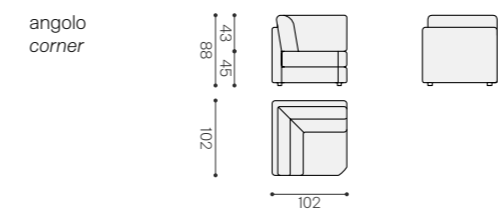
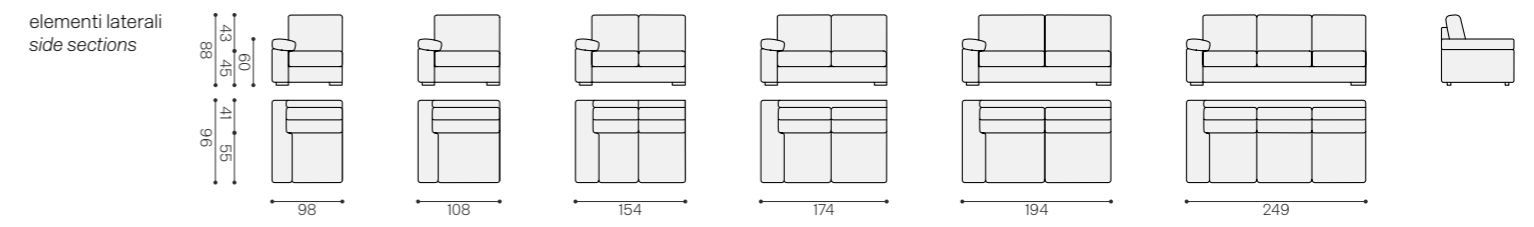
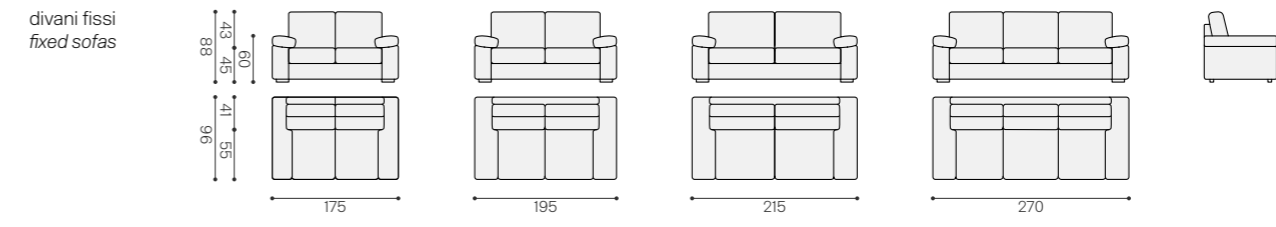
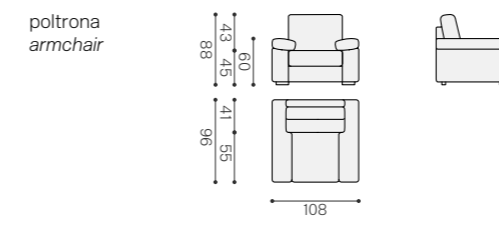

feni SI

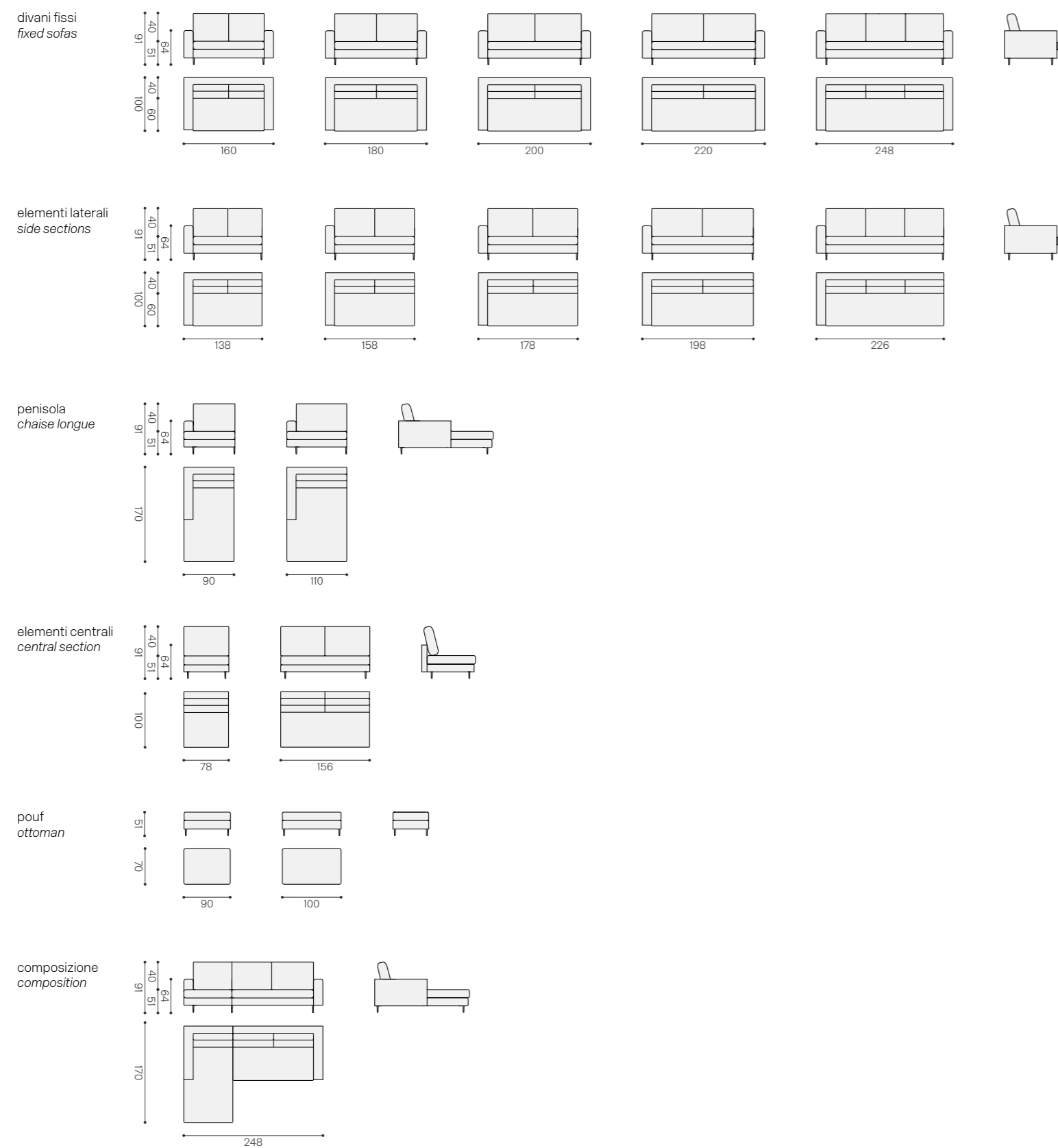

feni SD

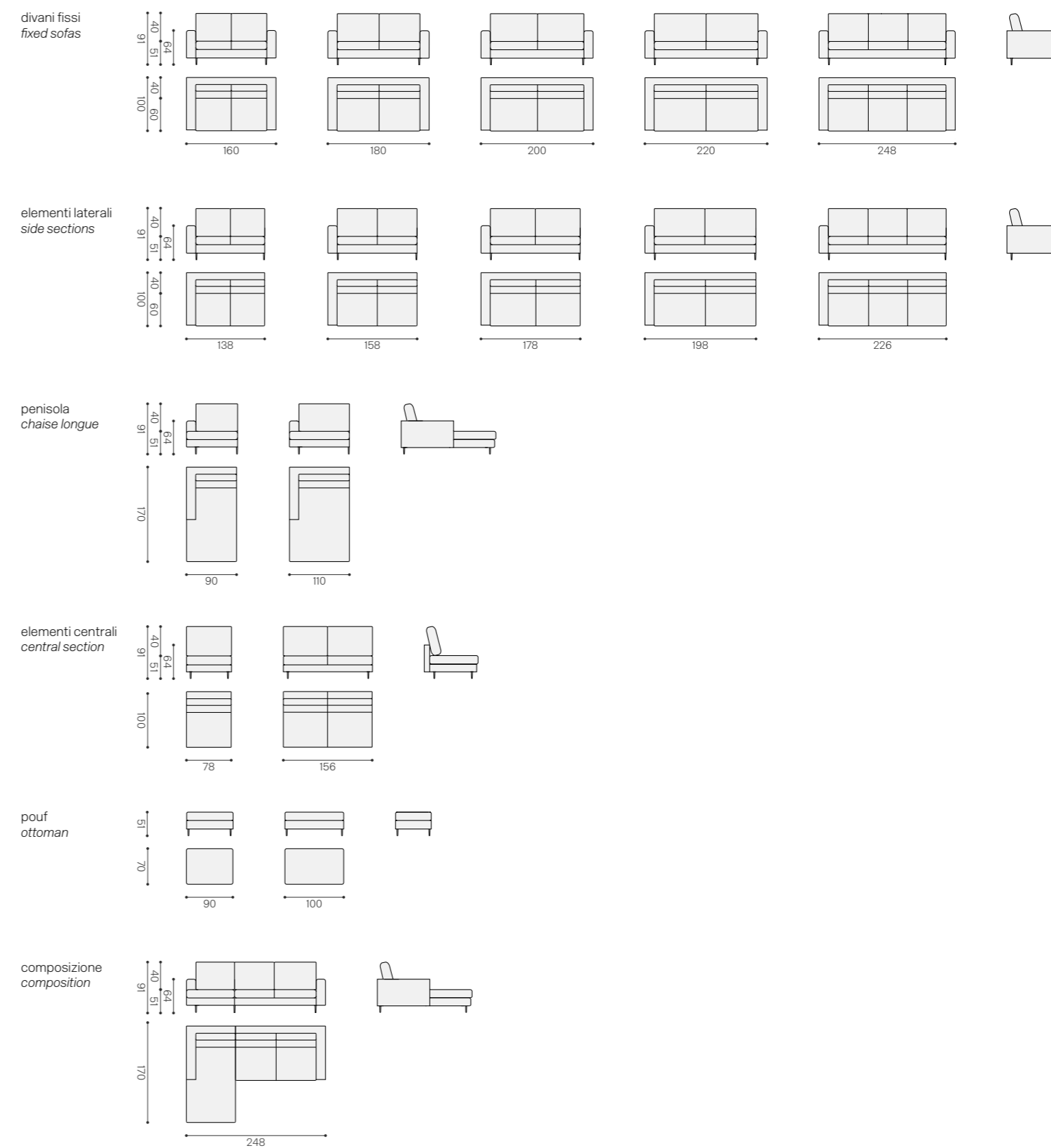

kommodo

poltrona
armchair

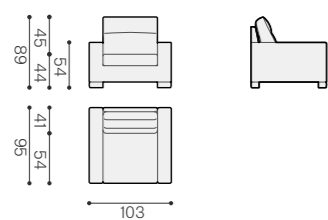

divani fissi
fixed sofas

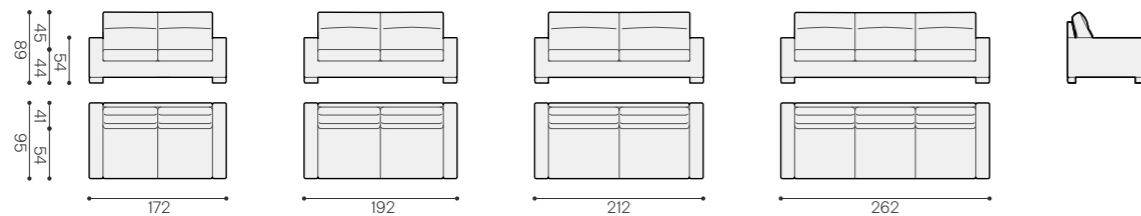

elementi laterali
side sections

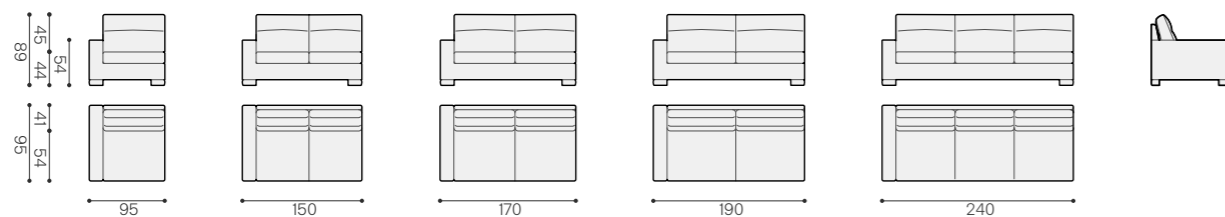

angolo chiuso
closed corner

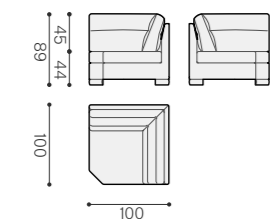

penisola
chaise longue

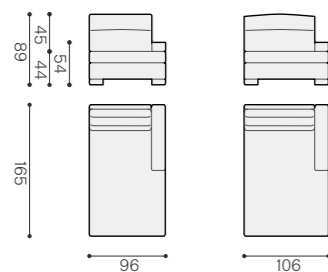

dormeuse
daybed

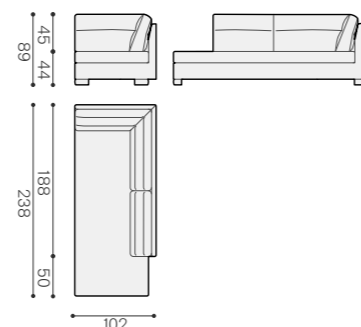

pouf
ottoman

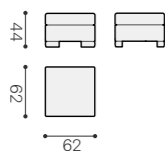

composizione
composition

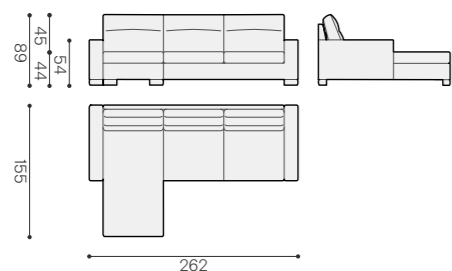

soft

divani fissi
fixed sofas

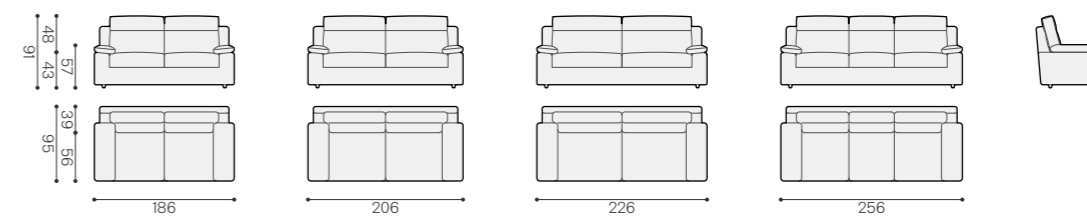

pouf
ottoman

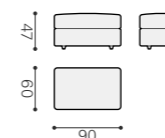

composizione
composition

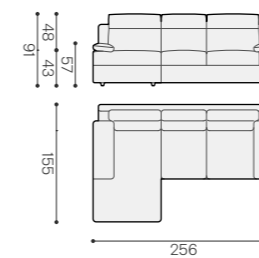

misvago

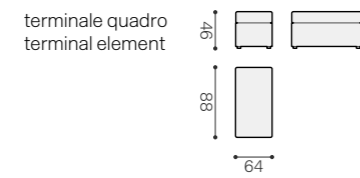
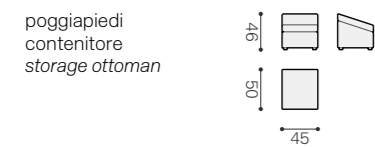
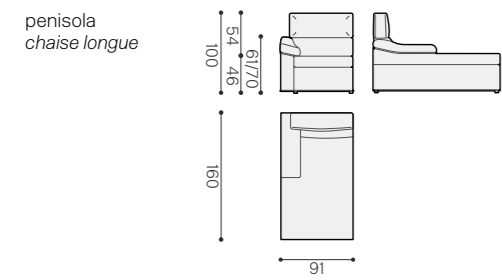
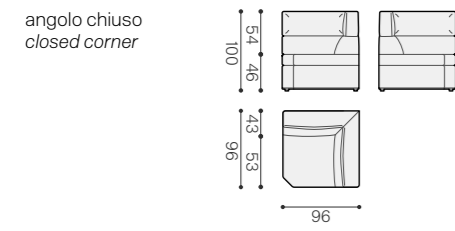
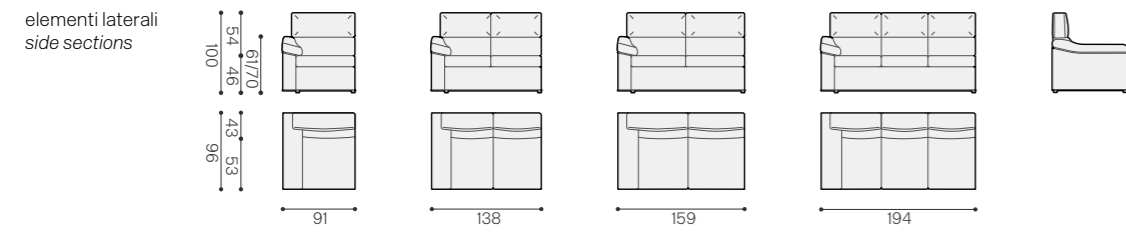
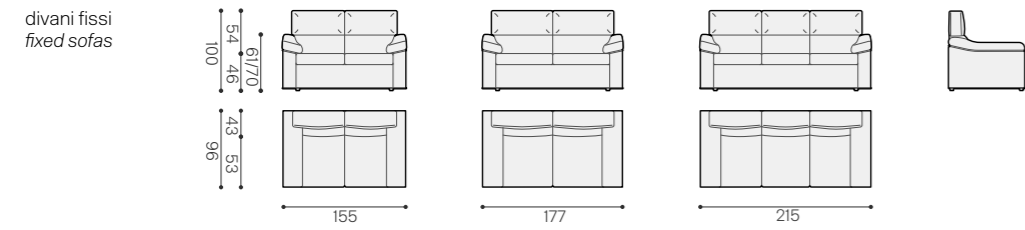
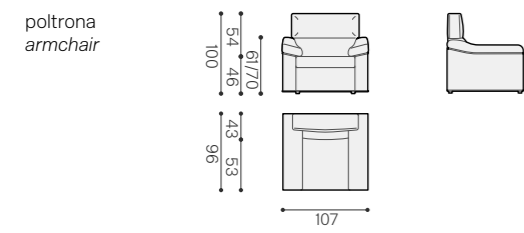

minimò

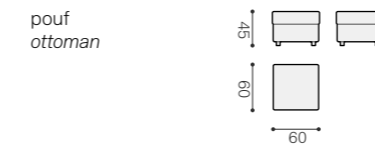
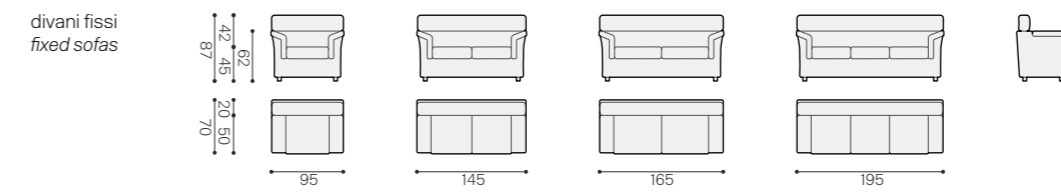

king

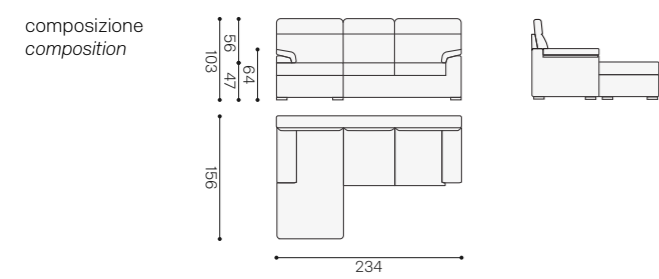
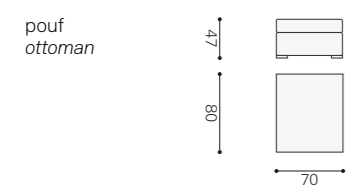
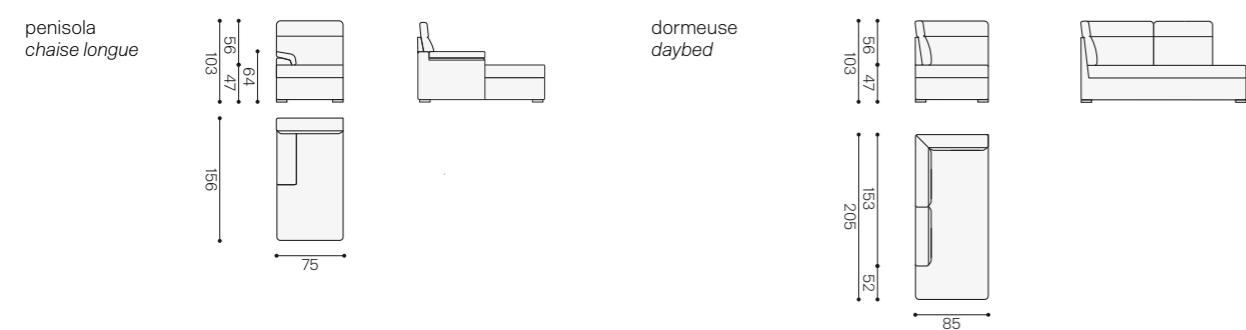
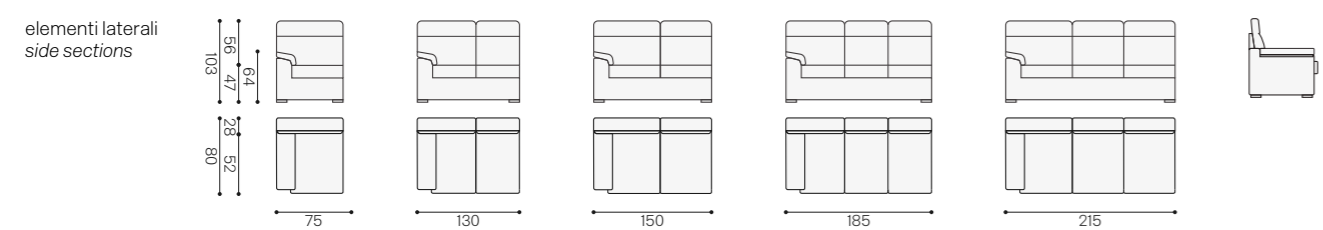
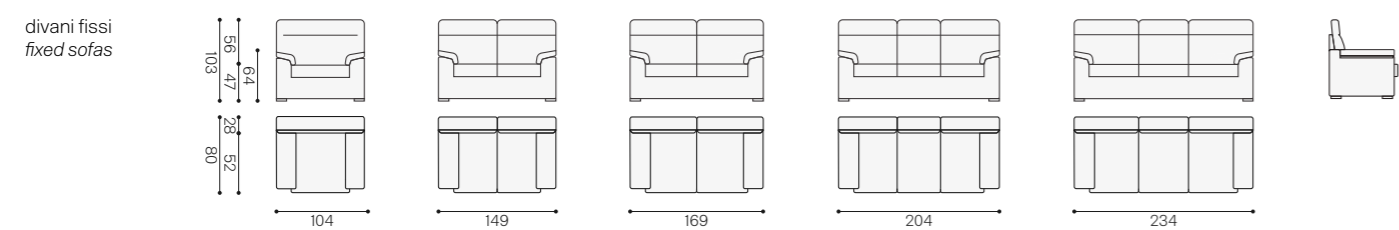

zelig

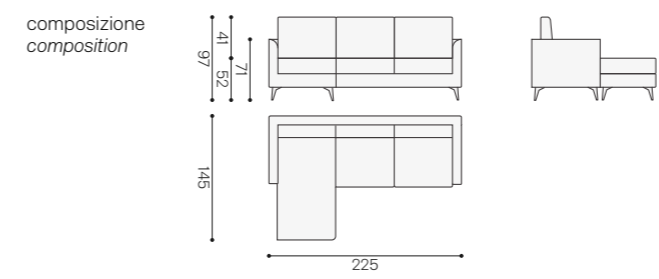
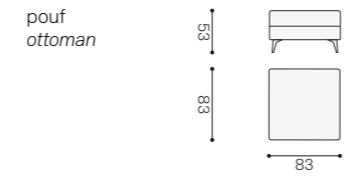
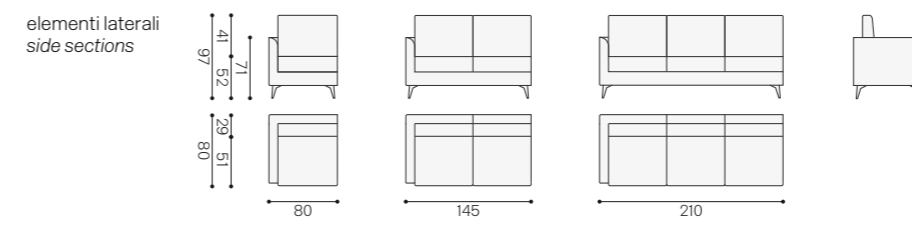
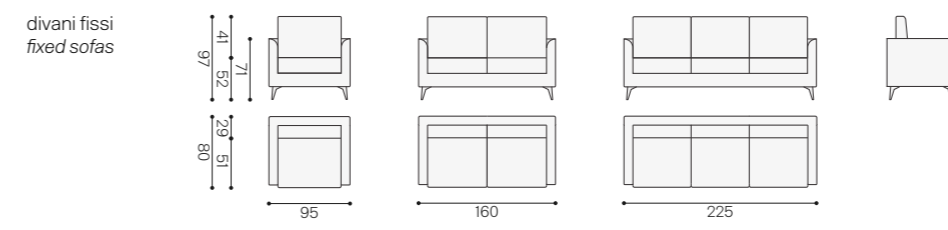

togo

divani fissi
fixed sofas

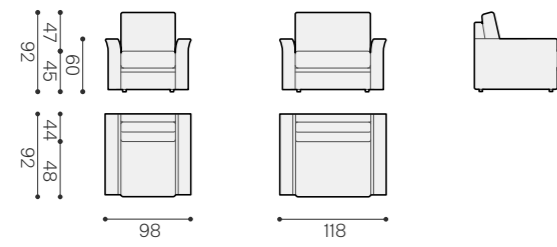

divani fissi
fixed sofas

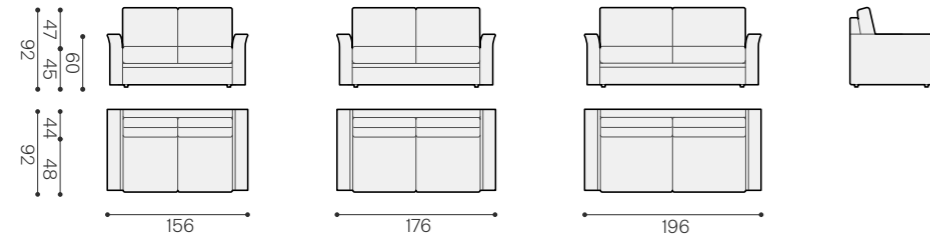

divani fissi
fixed sofas

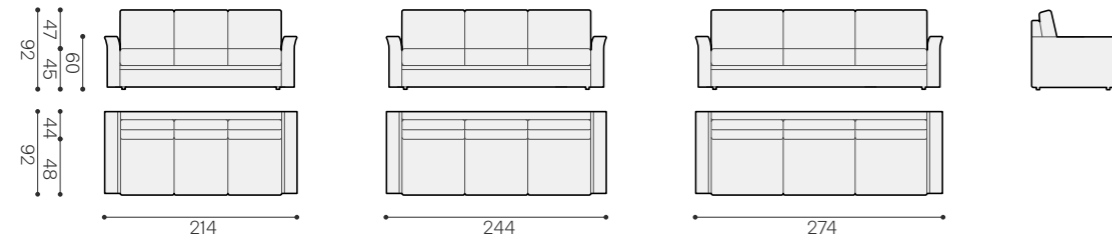

elementi laterali
side sections



elementi laterali
side sections

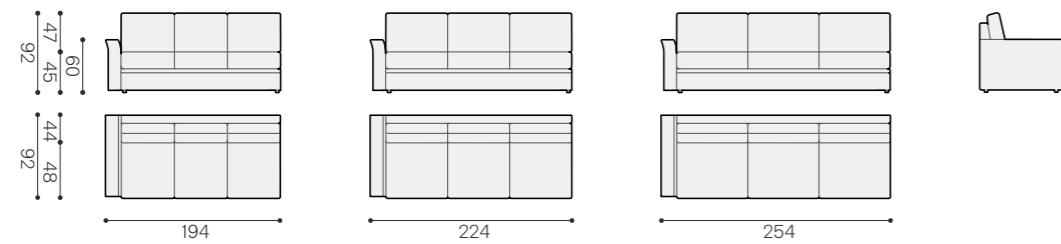

elementi centrali
central sections

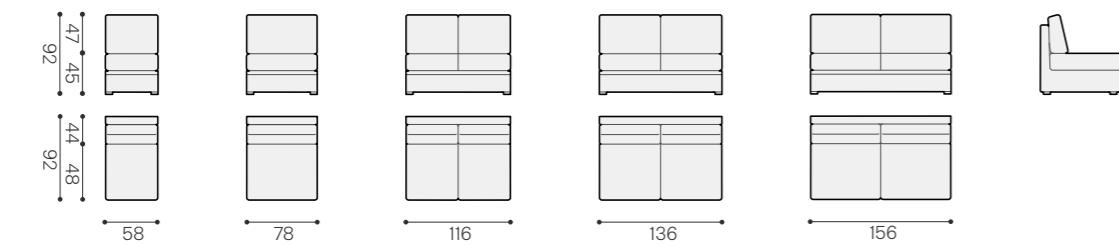

elementi centrali
central sections

angolo
corner

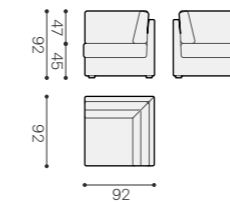

angolo aperto
open corner

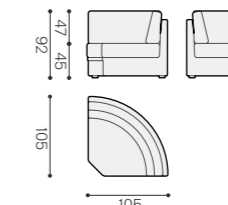

penisola
contentitore
storage
peninsula

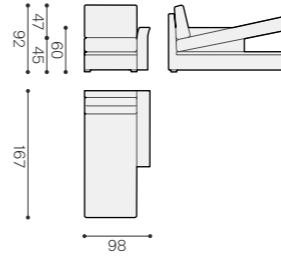

penisola
chaise longue

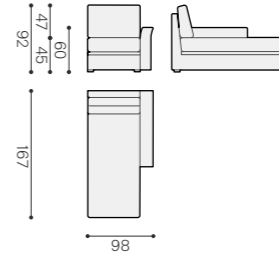

dormeuse
daybed

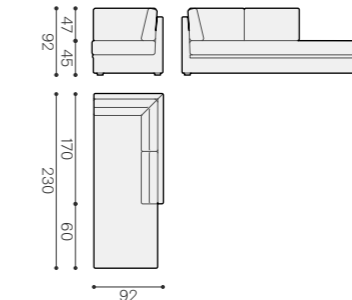
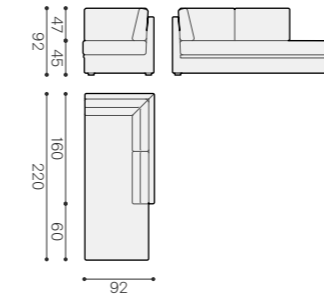

isola
island

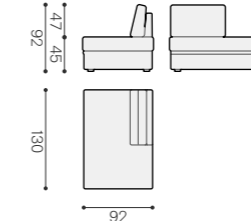
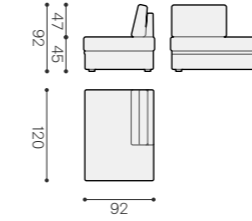

angolo panoramico
panoramic corner

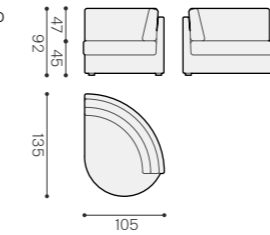

pouf
ottoman

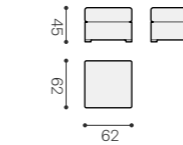

poltrona
armchair

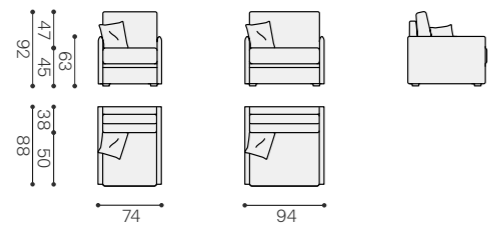

divani fissi
fixed sofas

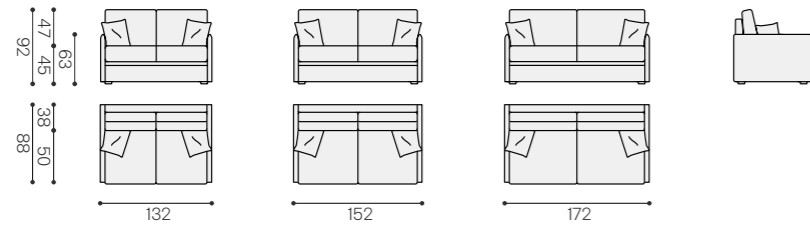

divani fissi
fixed sofas

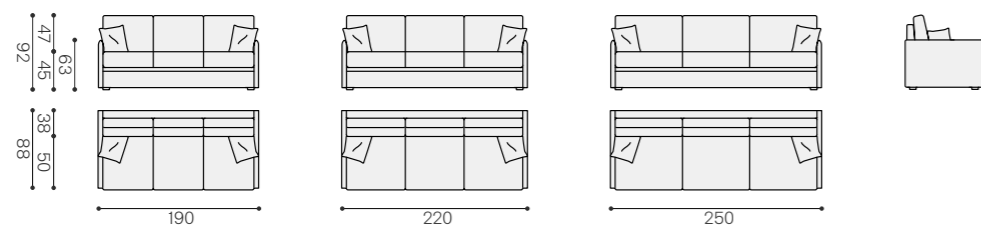

elementi laterali
side sections

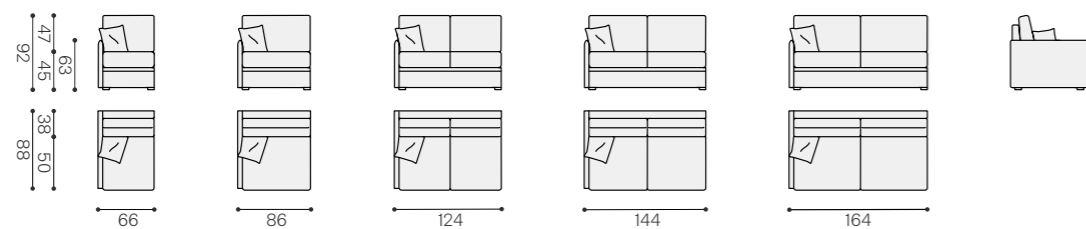

elementi laterali
side sections

elementi centrali
central sections

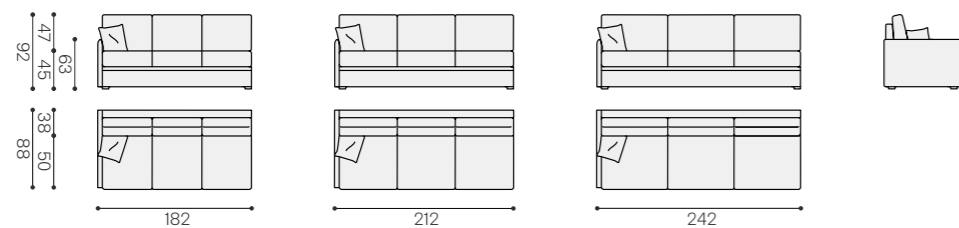

elementi centrali
central sections

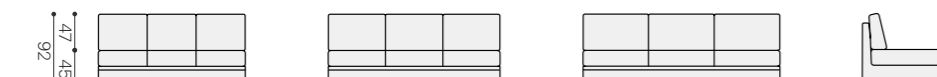
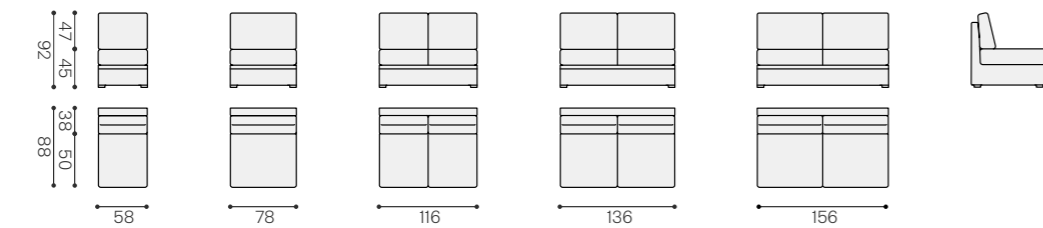

angolo
corner

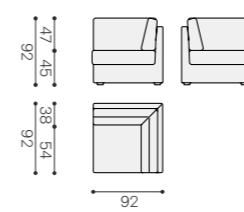

angolo aperto
open corner

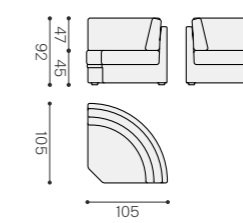

penisola
contentitore
storage
peninsula

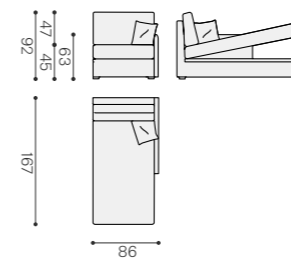

penisola
chaise longue

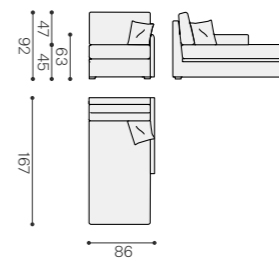

dormeuse
daybed

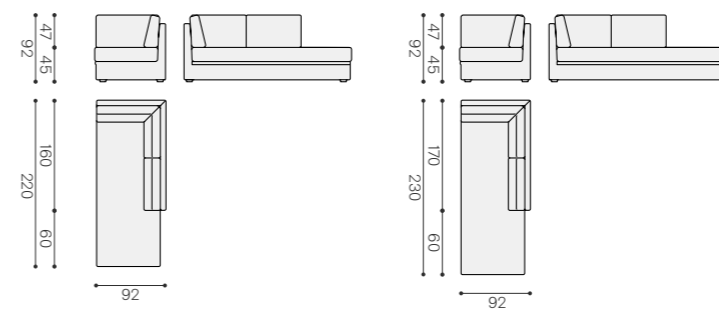

isola
island

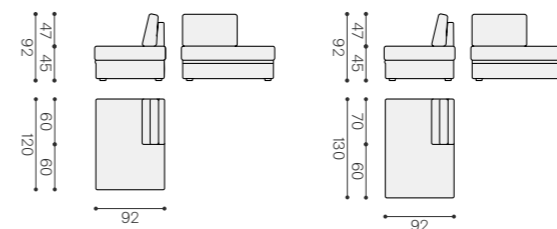

angolo panoramico
panoramic corner

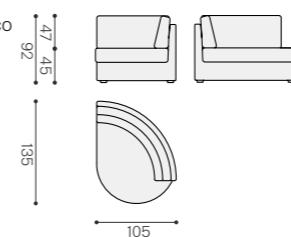

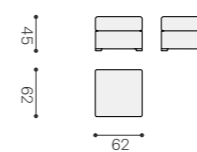

pouf
ottoman

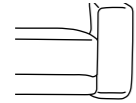
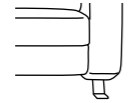
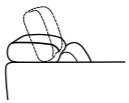

Riepilogo accessori e caratteristiche

Accessories and features summary

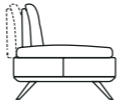
| |  |  |  |  |  |
|---------|---|---|---|---|---|
| Modello | Piedino a terra | Piedino alto | Poggiatesta regolabile | Schienale in piuma | Schienale basculante |
| Astro | ● | | | | |
| Avalon | ● | | ● | | |
| Feni SD | | ● | | ● | |
| Feni SI | | ● | | ● | |
| King | ● | | | | |
| Kommodo | ● | | | | |
| Minimò | ● | | | | |
| Misvago | ● | | ● | ● | |
| Ray's | ● | | | | |
| Soft | ● | | | ● | |
| Tablet | | ● | ● | | |
| Togo | ● | | | | |
| Tylor | | ● | ● | | |
| Volaria | | ● | | ● | |
| Yoao | ● | | | | |
| Zelig | | ● | | | |

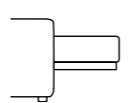
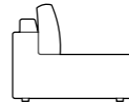
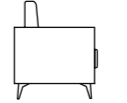
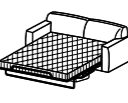
|  |  |  |  |
|---|---|---|---|
| Seduta estraibile | Seduta monoscocca | Profondità ridotta | Versione letto |
| | | | ● |
| | | | |
| | | | |
| | | | |
| | | ● | |
| | | | ● |
| | | ● | ● |
| | | | ● |
| | | | ● |
| | | | ● |
| | | | |
| | | | ● |
| | | | |
| | | | |
| | | | |
| | | | |
| | | | |
| | | | ● |
| | | | |
| | | ● | |



complementi
complements

bloom



Poltrona Bloom

Bloom è la poltrona dal design moderno e innovativo caratterizzata dalla grande comodità della seduta avvolgente la quale accoglie come in un abbraccio chi vi si abbandona. Bloom è disponibile con base girevole, braccioli, seduta e schienale si fondono in un continuum che caratterizza gli ambienti in cui viene posizionata, portando un tocco di elegante freschezza.

Bloom armchair

Bloom is the armchair with a modern and innovative design characterized by the great comfort of the enveloping seat which welcomes those who abandon themselves like an embrace. Bloom is available with a swivel base, armrests, seat and backrest merge into a continuum that characterizes the environments in which it is installed, bringing a touch of elegant freshness.

joy



Poltrona Joy

Piccola isola di relax, la poltroncina Joy valorizzano gli spazi di casa, completando il living e la camera da letto con un tocco chic e sofisticato. Questa preziosa architettura in miniatura, ricorda un fiore e con la sua forma avvolgente accoglie con un caloroso abbraccio chi si accomoda.

Joy armchair

A small island of relaxation, the Joy armchair enhances home spaces, completing the living room and bedroom with a chic and sophisticated touch. This precious miniature architecture recalls a flower and with its enveloping shape welcomes those who sit down with a warm embrace.

globe



Poltrona Globe

In pelle o tessuto non sfoderabili, questa poltrona dal design unico ed inconfondibile è caratterizzato da una struttura in metallo schiumato a freddo e scocca dalla forma avvolgente, oltre che da un sistema girevole e basculante in grado di assicurare il massimo comfort di seduta.

Globe armchair

Available in both non-removable leather and fabric, this armchair has a unique and unmistakable design. It's characterized by a cold-foamed metal structure and a wraparound shell, as well as a revolving and tilting system that ensures maximum seating comfort.

yoox



Poltrona Yoox

Yoox è una poltrona confortevole ed elegante dallo stile estremamente rigoroso, in cui le esili staffe metalliche di sostegno donano all'intera struttura, non solo una leggerezza unica, ma anche un tocco di originalità e brio in più.

Yoox armchair

Yoox is a comfortable and elegant armchair with an extremely rigorous style. The slender metal support brackets give to the whole frame, not only a unique lightness, but also a touch of originality and verve.

liria



Poltrona Liria

Liria è la versione 4.0 della classica poltrona da lettura che qui, sotto le sapienti mani dei nostri artigiani, viene alleggerita e rivisitata grazie all'introduzione di sveltanti piedini in metallo. Le linee arrotondate si fanno ancora più avvolgenti e sinuose, mentre il materiale di pregio del rivestimento, la trasforma nel punto focale sia di ambienti classici che moderni.

Liria armchair

Liria is the 4.0 version of the classic reading chair that here, under the expert hands of our craftsmen, it's lightened and revisited due to the introduction of slender metal feet. The traditional rounded lines became even more enveloping and sinuous, while the precious material of the covering has transformed it into the focal point of both classic and modern setting.



Ioto

Poltrona Loto B

Bellezza essenziale, funzionalità e design. Loto B è una poltrona dalla geometria semplice e dallo stile moderno; il complemento ideale da abbinare a Format. La forma cubica compatta è resa meno severa dalla staffa centrale in acciaio cromato che, oltre ad una inaspettata leggerezza, le dona grande dinamicità.

Loto B armchair

Essential beauty, functionality and design. Loto B is a simple and geometric armchair with a modern style; the ideal complement to combine with Format sofa. The compact cubic shape is made less severe by the central chrome steel bracket that, in addition to an unexpected lightness, gives it great dynamism.





Poltrona Loto A

Serietà, rigore ed essenzialità. Sono questi i termini che meglio descrivono Loto A: una poltrona dalla geometria semplice, quasi archetipa, e dallo stile assolutamente contemporaneo. La forma cubica compatta è resa meno severa dalle staffe in acciaio cromato che le donano una inaspettata leggerezza.

Loto A armchair

Seriousness, strictness and essentiality. These terms better describe this armchair characterized by a simple, almost archetypal geometry and an absolutely contemporary style. The chrome steel brackets offer an unexpected lightness to the compact cubic shape of Loto A.



mollis



Poltrona Mollis

Il morbido profilo di Mollis è un invito ad abbandonarsi al totale relax ascoltando musica o leggendo un buon libro. La sua forma sinuosa e leggera, resa ancora più attraente dai morbidi cuscini con imbottitura in misto piuma in camere separate, si esprime al meglio nella versione chaise longue con l'aggiunta del pouf frontale. Mollis è una poltrona di design studiata per valorizzare il living, completamente sfoderabile, disponibile in diverse varianti di tessuto e colori.

Mollis armchair

Mollis' soft outline is a clear invitation to indulge in total relaxation, listening the music or reading a book. Its sinuous and light shape, made even more attractive by the soft cushions with mixed feather padding in separate rooms, gives its best in the chaise longue version with the addition of the ottoman. Mollis is a design armchair, with a completely removable cover, available in different fabrics and colors, able to enhance every type of living room.

vanity

Poltrona Vanity

Vanity è una poltrona dallo stile contemporaneo e sobrio, caratterizzata da un'ampia e confortevole seduta in materiale indeformabile. Le sue forme nitide ed essenziali sono rese più vivaci dalla struttura metallica verniciata e dagli inserti di tessuto sui braccioli, dello stesso tono del resto della poltrona. La grande varietà cromatica dei rivestimenti e della struttura metallica, consentono a Vanity di essere il complemento perfetto per ogni arredo.

Vanity armchair

Vanity is an armchair with a contemporary and sober style, characterized by a large and comfortable seat made of crushproof material. The clear and essential shape is enhanced by the painted metal framework and the colored fabric inserts on the armrests. Vanity is the perfect complement for every piece of furniture due to the great chromatic variety of the coverings and the metal framework.





bea



Poltrona Bea

Rigolotti rielabora, con il suo tocco inconfondibile, la più classica tra le poltrone da lettura trasformandola in un complemento d'arredo estremamente versatile, in grado di integrarsi perfettamente in ogni ambiente. I rivestimenti, nelle tonalità più trendy, e l'uso di piedini svettanti in acciaio cromato la rendono un jolly imperdibile per l'arredo di ambienti sia moderni che classici.

Bea armchair

Rigolotti changes, with its unmistakable touch, the most classic of reading armchairs, transforming it into an extremely versatile furnishing complements able to integrate itself in every environment. The coverings, in the most trendy colors, and the use of chromed steel feet make it, then, an unmissable piece for both modern and classic furnishing.

viva

Originalità e semplicità si uniscono per dar vita a Viva, un sistema componibile di sedute ad uno, due posti e ad angolo, estremamente comode e funzionali, dotate di serie di imbottitura ignifuga. Così essenziali nel design, tanto da richiamare alla mente i disegni dei bambini, consentono una grande flessibilità e versatilità.

Originality and simplicity are combined here and create Viva, an extremely comfortable and functional modular system with one/two seats and angular sections, equipped with standard fireproof padding. Its design is incredible essential, so that to remind children's drawings, and allow great flexibility and versatility.



Con Viva è facile creare angoli di convivialità: è sufficiente spostare un elemento per trasformare lo spazio e farlo diventare altro. I moduli sono estremamente flessibili ed intercambiabili tra loro dando vita a spazi di relax sempre diversi. L'ampia offerta di rivestimenti nei colori trend del momento, garantiscono un tocco ulteriore di modernità.

Viva allows to easily make original convivial zones: you can just move an element to transform the entire space and create something else. Modules are extremely flexible and interchangeable, creating always different relaxing areas. The wide range of trendy coverings available, guarantees a further touch of modernity.



pratica



Poltrona Pratica

L'alta qualità artigianale che ci contraddistingue si fa interprete della poltroncina da sala d'attesa per eccellenza dando vita a Pratica. La sua forma classica e senza tempo viene valorizzata dalla qualità dei rivestimenti e dalla purezza dei dettagli.

Pratica armchair

Our well-known high craftsmanship skills decipher the most iconic and traditional waiting room armchair, transforming it in our Pratica armchair. Its classic and timeless shape is enhanced by the quality of the coverings and the purity of the details.

soffice



Poltrona Soffice

Versione contemporanea della classica poltroncina da sala d'attesa, Soffice non passa inosservata. L'uso di colori di tendenza, come il viola, o dell'insolito e originale cuscino dello schienale la rende una poltroncina dalla grande personalità.

Soffice armchair

Contemporary version of the classic waiting room armchair that, due to its unique character, it doesn't go unnoticed. The use of trendy colors, such as purple, or the unusual and original backrest cushion, make it a small armchair with a great personality.

pouf family

Il pouf è un elemento molto versatile, oltre ad essere un elemento decorativo molto originale, si può utilizzare per appoggiare i piedi o come seduta aggiuntiva in salotto. Qualunque sia la funzione che si decide di dargli, il pouff conferiscono al soggiorno un'atmosfera rilassata, aggiungendo una sensazione di accoglienza allo spazio.

The pouf is a very versatile element, as well as being a very original decorative element, it can be used to rest your feet or as an additional seat in the living room. Whatever function you decide to give it, poufs give the living room a relaxed atmosphere, adding a welcoming feeling to the space.



Grazie al loro design e ai loro colori, i nostri pouf sono ideali per qualsiasi tipo di stanza, piccola o grande e per qualsiasi stagione dell'anno. I pouf daranno un tocco di colore e di classe all'angolo della casa in cui vengono utilizzati e pur occupando poco spazio, hanno sempre un grande impatto visivo.

Thanks to their design and colours, our poufs are ideal for any type of room, large or small, and for any season of the year. The poufs will give a touch of color and class to the corner of the house where they are used and while taking up little space, they always have a great visual impact.



tecnica
technical

bloom

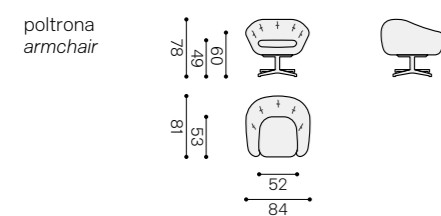

joy

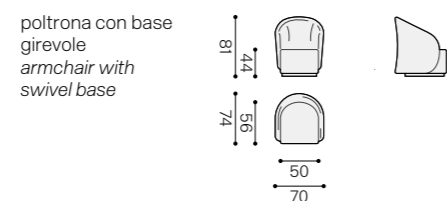
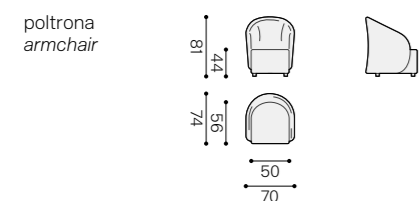

globe

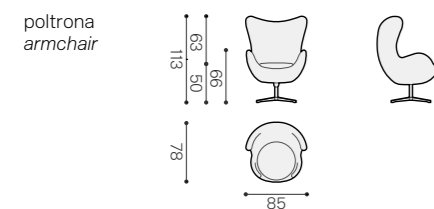

yoox

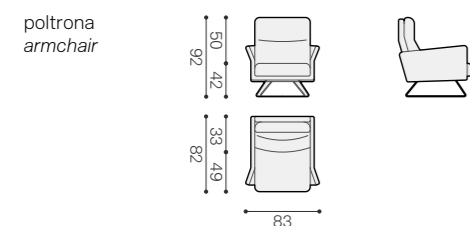

liria

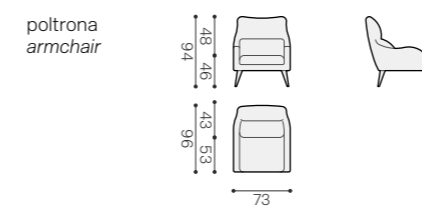

loto A

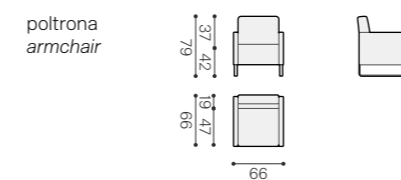

loto B

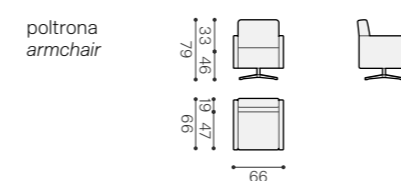

mollis

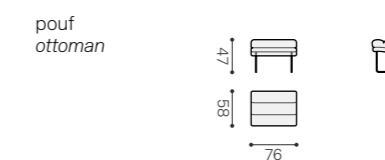
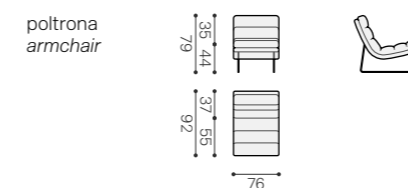

vanity

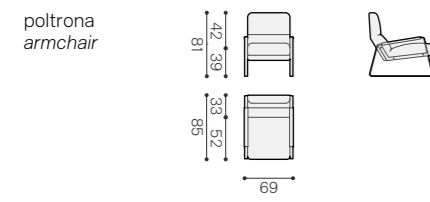

bea

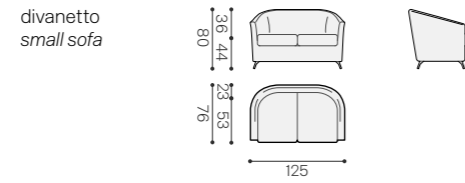
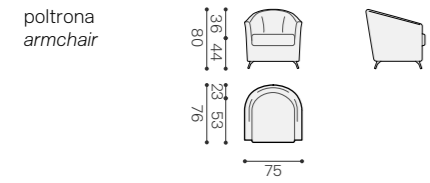

viva

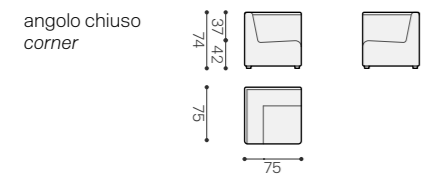
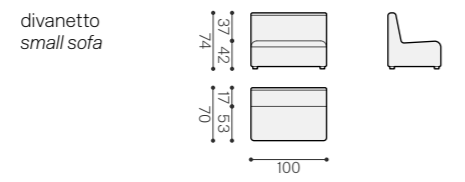
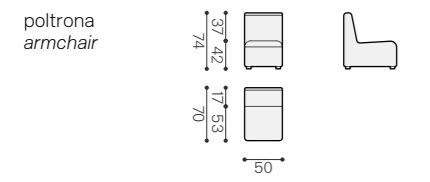

pratica

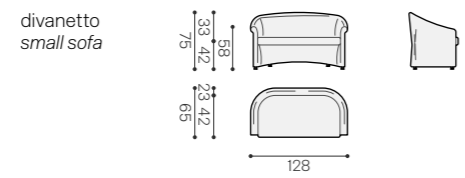
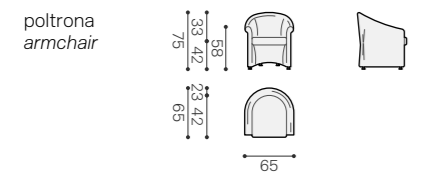

soffice

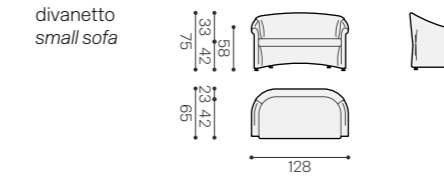
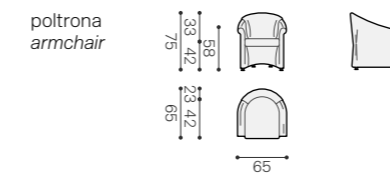

Family Pouf

cubo small

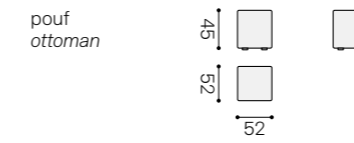

cubo big

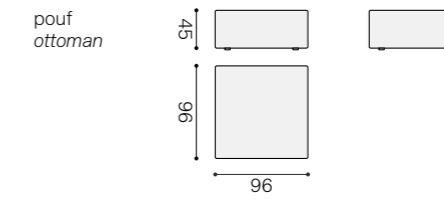

round small

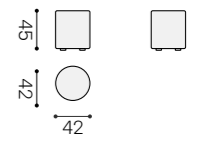

round big

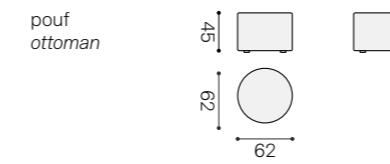

esa

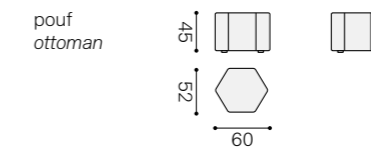

oval

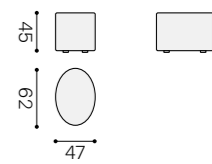

Graphic Design

grucciadesign.

Concept Cover

Monogramma Studio

Photo

Studio Emozioni

3D Image

Nerokubo

Styling Photo

Luigina Pilloni

Pre-Press

Studio Emozioni



Rigosalotti srl

Via Ponte di Sotto, 31/A

33070 Brugnera PN

Italia

T +39 0434 624680

F +39 0434 624842

info@rigosalotti.it

www.rigosalotti.it

Rigosalotti
Via Ponte di Sotto, 31/A
33070 Brugnera PN
Italia

T +39 0434 624680
F +39 0434 624842
info@rigosalotti.it
www.rigosalotti.it